

Subject: What electric vehicles can learn from the solar market : Renew Economy

From: Sch 4 CTPI

To: mangocube6@yahoo.co.uk;

Date: Wednesday, 4 November 2015, 1:12

Hey Mark, Sch 4 CTPI

hope David saw this.. it's something I would love to work on..

hope all is well...

<http://reneweconomy.com.au/2015/what-electric-vehicles-can-learn-from-the-solar-market-65696>

What electric vehicles can learn from the solar market

RMI



Across the US and the world, unsubsidised solar energy is reaching cost parity with fossil fuels. The same cannot (yet) be said for electric vehicles (EV) compared to gasoline-burning ones. While unsubsidized EVs have not reached cost parity with gasoline vehicles for the average driver, EV sales are surging in three Colorado counties by employing a tactic that helped make residential solar more affordable to the mass market.

Inspired by the success of pooled purchasing programs for residential rooftop solar (sometimes called “solarize” campaigns), Boulder County invited Adams and Denver counties to team up with Vote Solar—a nonprofit advocacy organization that administers programs to facilitate residential solar group purchases*—to create Solar Benefits Colorado and engage EV manufacturers and dealers to see if the same rationale could be applied to pooled purchases of EVs.

It turns out it can: Originally through October 31, 2015 and now extended through the end of the year, customers can take advantage of a discount up to \$8,600 on a 2015 Nissan LEAF with Quick Charge Package and zero-percent financing for up to 72 months. This discount, co-developed by the counties, Nissan North America, and Boulder Nissan, brings the entry-level LEAF S down to \$23,461 from \$31,810 before the federal (\$7,500) and state (~\$5,000) tax credits for which the LEAF also qualifies. This price is lower than Kelley Blue Book's estimated fair purchase price of \$28,255, meaning the deal is not only pre-negotiated, but far below what customers could get by haggling. This deal doesn't involve tax credits, subsidies, lobbying, handouts or regulation. It just involves pure business sense for consumers, dealerships, and EV manufacturers alike.

The power of community buying

While EVs enjoy lower operating and maintenance costs than their gas-powered counterparts, their higher upfront cost can be a barrier to adoption—either through sticker shock or simply because customers lack the required initial capital. There are already measures to address this barrier at the federal and state level in the form of tax breaks. However, these incentives weren't driving EV adoption fast enough for these three communities. Boulder County, for example, has a goal to achieve an 80-percent reduction in greenhouse gas emissions from the transportation sector by 2050. Part of the problem is that tax credits must be claimed at tax time, the spring following the EV purchase. But incentives available at the time of purchase have a far greater impact on EV sales. With the upfront discount, monthly payments are lower, helping to make the LEAF available to more consumers.

These economics evidently create a compelling incentive to go electric. In just two months, Boulder Nissan sold over 150 LEAFs through the program, with more than 300 additional people in the pipeline. To put that in perspective, Boulder Nissan typically sells 15 to 20 LEAFs per month (~10 percent of total sales), meaning that its LEAF sales have increased almost 300 percent during the program.

This volume of sales also highlights the benefits of pooled purchasing for Nissan corporate and the Boulder Nissan dealership—the corporate partners for this program. In our age of choices and competition, it's now about creating marketing economies of scale. While Nissan sacrifices some revenue by providing the discount, it's saving on customer acquisition fees, marketing, and even the transaction costs (and potential customer losses) spent negotiating vehicle prices with prospective customers. This marketing doesn't stop when the deal expires either. Thanks to the program, there are now 150 new Colorado LEAF owners and counting spreading the word and dispelling public misconceptions about EVs. That is more powerful than any marketing campaign.

Nissan also benefits from the special type of publicity delivered through the program—community based social marketing. Instead of Nissan itself promoting the deal, the program is promoted through a network of municipalities, universities, large employers, and the newest LEAF converts. Sending the message through a coalition of trustworthy sources—rather than from the company that stands to benefit from the sales—brings intrinsic integrity to the deal. Not to mention that packaging the Nissan LEAF alongside residential solar conveniently targets consumers who are already likely amicable to buying an EV. It's like putting chocolate bars at the checkout counter of supermarkets: the hungry customers are already there; you just need to put the option in their line of vision.

Replicating successful public private partnerships

While the deal on the LEAF sounds too good to be true, it simply required bringing together unlikely stakeholders with aligned interests to connect the dots on a public-private partnership that already made economic sense. The huge success of the program also lies in the unique value added by each stakeholder in the chain. At the corporate level, the support to make bulk purchasing economics and logistics possible was driven by a forward-looking vision of an EV dominated market and the need for a critical mass of EVs to drive this revolution. At the dealership level, finding knowledgeable and EV-dedicated salespeople who understand not only the technology but also work to ensure it meets the customer's needs, leads to LEAF

owners who become EV ambassadors. And finally, at the grassroots level, the counties pursued and championed the deal as one that is truly for the greater good.

While Adams, Boulder, and Denver Counties deserve credit for the novelty and boldness to pilot this idea, the beauty of the story is that it's replicable across the country. All that's needed is the will and openness to collaborate.

**The description of Vote Solar has been corrected. Vote Solar does not sell residential solar systems; Vote Solar is a national non-profit public advocacy organization that advances policies and administers programs that make solar more accessible and more affordable to more Americans.*

RenewEconomy Free Daily Newsletter

Attachments

- rsz_blog_2015_10_29-2.jpg (52.92 KB)

Released under RTI Act - TMR

Subject: US giant enters Australia market to take suburbs off the grid | One Step Off The Grid

From: Sch 4 CTPI

To: mangocube6@yahoo.co.uk;

Date: Thursday, 5 November 2015, 15:34

It has started...

I think the days of large dividends from the Ergon, energex and power link could be numbered.

<http://onestepoffthegrid.com.au/us-giant-enters-australia-market-to-take-suburbs-off-the-grid/>

US giant enters Australia market to take suburbs off the grid

The energy offshoot of US asset management giant Brookfield has signed a deal with property group LWP to build a new suburb near Newcastle that will not connect to the grid, in a move that could be a blueprint for more such development and shapes as one of the biggest challenges to the incumbent energy industry yet.

Brookfield Energy and its majority owned "multi-utility" offshoot Flow Systems are planning to build a micro-grid based around renewable energy and battery storage that will mean the new housing development of Huntlee will not need to connect to the grid. It will be entirely self-sustaining.

Flow Systems, which already operates as a water utility in Australia, is in the process of obtaining an electricity utility licence too, making it the first to establish itself in competition to the vast transmission and distribution network businesses that dominate the Australian market.

The economics of the micro-grid are simple. When building a new subdivision, property developers are required to pay millions of dollars, or even tens of millions of dollars, in network development, and then "gift" that asset to the network, who then charges connection fees and rentals to the residents.

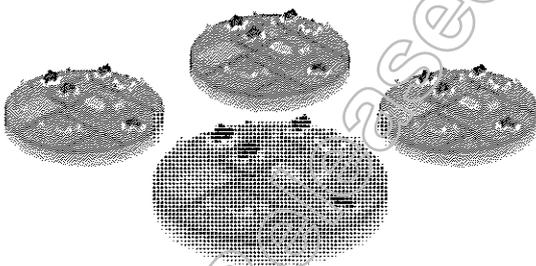

Brookfield, Flow Systems and the property developers have figured out it is probably cheaper to buy-pass the network altogether, and create their own micro-grid.

The US giants are not the only ones to see an opportunity in micro-grids. Ross Garnaut last month launched and will chair a new company called Zen Energy, that will focus on new suburban developments, and the opportunities in taking local communities off the grid if they wish.

In NSW, Siemens has made a proposal to the Byron Bay shire council to turn its local system into a renewable-focused micro-grid, while smaller towns such as Tyalgum are considering their own proposal to "buy back" the grid.

Even network operators recognise the economic value in such proposals, given the huge cost of poles and wires and the massive cross-subsidies that support regional grids.

The Brookfield/Flow/LWP consortium has won funding from the Australian Renewable Energy Agency to continue a feasibility study into the idea. ARENA will provide \$442,000 out of the \$1.1 million initial study.

ARENA CEO Ivor Frischknecht said the initiative could set a precedent for other residential developments, and accelerate the uptake of renewable energy in Australia.

“There are a number of regulatory challenges and constraints and technical risks facing microgrids. Brookfield will share key insights about overcoming these barriers with the energy industry.”

Flow Systems said its goal was to increase the amount of renewables into the grid, at no extra cost.

“Proving this can be done technically and commercially will be a real step change for embedded renewables in this country,” managing director Terry Leckie said.

Huntlee will be the first new town in the Hunter Valley in 50 years and will house 20,000 new residents in 7,500 homes.

LWP project director Stephen Thompson “embracing the very latest in renewables” would be a key factor in ensuring the town’s prosperous future.

“We’re excited by the possibility of developing Australia’s first town-scale greenfield microgrid and all of the advantages that level of innovation would bring to our residents and commercial operators.

“If the proposed model for Huntlee is successful, it will positively influence the nature of housing, employment, business, transportation and education for our future residents.”

Brookfield, Flow Systems and LWP will work with German energy services giant Siemens, as well as the CSIRO and Kinesis, in designing the grids.

Warner Priest, the head of micro-grid development for Siemens in Australia, told RenewEconomy last month that a suburb of around 10,000 houses would need a micro-grid capacity of around 50MW.

One scenario would be some 40MW of rooftop solar (an average of around 4kW per home), and an array of centralised and decentralised battery storage totalling 10MW/40MWh.

It would also include a series of gas-fuelled gas generators, about 30MW in total – 12x2MW generators and 8x500kW generators which could – within a few years – be replaced by renewable gas fuel such as hydrogen, or cheaper battery storage.

Environment minister Greg Hunt said as renewable energy and battery storage become cheaper, the case for building new suburbs independent to the grid will continue to become stronger.

“It would be the first time in Australia that a new suburb near existing infrastructure relied solely on renewable energy and enabling technologies, if Brookfield successfully makes the case and the developer decides to go ahead with the option,” he said in a statement.

Brookfield is a global alternative asset manager with more than \$200 billion of assets under management. It is believed to have assigned more than \$2 billion for potential developments in Australia, particularly in the micro-grid area.

Flow Systems will lead its push into Australia. It says its mission is “to build low carbon communities of the future that enhance livability, are self-sufficient and reduce costs to government, developers and the community.

Attachments

- flow-systems-300x152.jpg (10.63 KB)

Subject: Fwd: ETU Feedback Energy Industry Stakeholder Forum - 3 November 2015

From: Lance McCallum <[redacted] Sch 4 CTPI>

To: mangocube6@yahoo.co.uk;

Date: Friday, 6 November 2015, 16:39

Comrade, fyi

----- Forwarded message -----

From: Lance McCallum <[redacted] Sch 4 CTPI>

Date: 6 November 2015 at 16:38

Subject: ETU Feedback Energy Industry Stakeholder Forum - 3 November 2015

To: NEMR <Nemr@dews.qld.gov.au>, RYAN Sue <Sue.Ryan@dnrm.qld.gov.au>, SIMSHAUSER Paul <Paul.Simshauser@dews.qld.gov.au>, BARR Benn <benn.barr@dews.qld.gov.au>, LEAVER Gayle <Gayle.Leaver@dews.qld.gov.au>, "denise.spinks@ministerial.qld.gov.au" <denise.spinks@ministerial.qld.gov.au>, "david.shankey@ministerial.qld.gov.au" <david.shankey@ministerial.qld.gov.au>

Hello all,

Thanks very much for the opportunity to attend the Energy Industry Stakeholder forum earlier this week to discuss the upcoming COAG Energy Council meeting. It is the first time that I've see this type proactive stakeholder engagement that has been sorely missing from the COAG Energy Council process, so congratulations. Having had a few days to reflect on the views that were shared at the forum, we would like to provide the following feedback on the specific agenda items that were discussed.

Climate Policy

Australia needs to have significantly more ambitious climate targets (renewable generation, GHG emission reduction, energy efficiency etc) than the current targets. The energy sector has major potential to contribute to meaningful climate action through generation, transmission and distribution. There are a wealth of studies from a range of reputable agencies, both domestic and international (eg CSIRO, IEA etc), that examine how the sector can take strong climate action but what is missing to date is a body of work from NEM regulatory agencies that applies that data to the NEM regulatory framework. The AEMC complied the Energy Market Frameworks in light of Climate Change Policies in 2009, but there has been little since. It is timely that consideration be given to tasking one or more agencies with providing the Council with updated advice on not only the frameworks, but on regulatory options on how to best adapt the market in the future. Any such work would clearly need to take into account post Paris outcomes. Queensland can be uniquely placed to be a leader in this space.

Emerging Technology

There was some feedback from stakeholders that energy storage technology should be unregulated and not form part of DBs RABs. We consider this position to be predicated on the assumption that all future storage technologies will only be adopted at a household level. There is no guarantee of this, in fact evidence points to storage easily occurring at a household/neighbourhood/substation/consolidated level simultaneously. It would be bad policy to effectively lockout non-household level storage options going forward. In this respect we support the contribution made by the Ergon CEO with regards to storage.

Governance

In our view one of the perennial challenges is the gap between the rapid rate of change of industry technologies against the comparatively glacial pace of regulatory reform and processes. While it is easy to say that there must be more flexibility built into the NEM regulatory environment, it is hard to achieve. Nonetheless it can be done, as was the case with recent rule changes to allow the AER more flexibility in the determination making process. We would also encourage consideration of a body of work to identify duplication or inefficiencies that exist between state and federal jurisdictions and suitable recommendations that may arise on how address any such instances.

Finally, for Ministers, we encourage you to be bold in your approach and open in your mindset. COAG processes in general, and the Energy Council in particular, can suffer from being beholden to their own bureaucratic inertia due to the industry being so heavily regulated and complex. There is a dire need for fresh thinking and a critical eye on the system that has delivered such unsatisfactory pricing outcomes.

Please don't hesitate to contact me should you wish to discuss further and congratulations once again on taking the initiative to hold the forum.

Best

Lance McCallum

National Policy Officer

M:

Sydney

P: 02 9663 3699 | F: 02 9663 5599

Suite 408, Level 4, 40 Harcourt Pde, Rosebery, NSW, 2018.

Brisbane

P: 07 3846 2477 | F: 07 3844 9851

41 Peel St, South Brisbane, QLD, 4101.

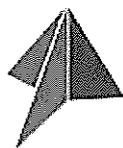

CEPU
COMMUNICATIONS
ELECTRICAL
PLUMBING
UNION

www.etunational.asn.au

twitter.com/ETU_national

facebook.com/ETUNational

The information contained in the e-mail is intended only for the use of the person(s) to whom it is addressed and may be confidential or contain legally privileged information. If you are not the intended recipient you are notified that any perusal, use, distribution, copying or disclosure is strictly prohibited. If you have received this e-mail in error please immediately advise us by return e-mail and delete the e-mail document without making a copy.

The Electrical Trades Union has virus scanning devices on our system but in no way do we represent that this communication (including any files attached) is free from computer viruses or other faults or defects. We will not be held liable to you or to any other person for loss and damage (including direct, consequential or economic loss or damage) however caused and whether by negligence or otherwise which may result directly or indirectly from the receipt or use of this communication or attached files.

--

Lance McCallum

NR

Sch 4 CTPI

Attachments

- image007.png (181 B)
- image004.jpg (2.97 KB)
- image002.jpg (2.96 KB)

Released under RTI Act - TMR

Subject: Re: ^_FYI^_...

From: Tam.VanAlphen@ministerial.qld.gov.au

To: mangocube6@yahoo.co.uk

Date: Saturday, 7 November 2015 10:47:10 AM AEST

Sounds good - stay safe with those so called "driverless" cars!!!

Sent from my iPhone

> On 6 Nov 2015, at 10:58 pm, Mark Bailey <mangocube6@yahoo.co.uk> wrote:

>

> Ah well. Let's chat tactics over weekend... M

>

> Sent from my iPhone

>

>> On 6 Nov 2015, at 5:28 PM, Tam van Alphen <Tam.VanAlphen@ministerial.qld.gov.au> wrote:

>>

>> Hmphf!

>>

>> Sent from my iPhone

>>

>>> On 6 Nov 2015, at 3:42 pm, Mark Bailey <mangocube6@yahoo.co.uk> wrote:

>>>

>>> @saveexit190: Member for Caloundra Mark McArdle is making urgent contact with the Department of Transport and Main Roads... <https://t.co/byyYCopNIS>

>>>

>>> Sent from my iPhone

>> This email, together with any attachments, is intended for the named recipient(s) only; and may contain privileged and confidential information. If received in error, you are asked to inform the sender as quickly as possible and delete this email and any copies of this from your computer system network.

>>

>> If not an intended recipient of this email, you must not copy, distribute or take any action(s) that relies on it; any form of disclosure, modification, distribution and /or publication of this email is also prohibited.

>>

>> Unless stated otherwise, this email represents only the views of the sender and not the views of the Queensland Government.

>>

>> Please consider the environment before printing this email.

This email, together with any attachments, is intended for the named recipient(s) only; and may contain privileged and confidential information. If received in error, you are asked to inform the sender as quickly as possible and delete this email and any copies of this from your computer system network.

If not an intended recipient of this email, you must not copy, distribute or take any action(s) that relies on it; any form of disclosure, modification, distribution and /or publication of this email is also prohibited.

Unless stated otherwise, this email represents only the views of the sender and not the views of the Queensland Government.

Please consider the environment before printing this email.

Subject: Very interesting: cost effective renewable alternative to fossil fuels

From: Sch 4 CTPI

To: mangocube6@yahoo.co.uk;

Date: Sunday, 8 November 2015, 0:21

Hey Mark.. this could be a very interesting development for Qld... and completely upend the fracking debate...

Suggest David take a look

<http://www.jouleunlimited.com/why-joule>

Why Joule?

Many technological alternatives to petroleum-derived fuels have been explored, and with good reason. Limited energy supplies, oil pricing volatility and environmental concerns have converged to create one of the greatest challenges of our time. Nearly \$700 billion is being invested in pursuit of diminishing petroleum, including newer and even riskier practices to obtain "unconventional oil" from oil sands and oil shale.

Joule offers an entirely new alternative: a CO₂-to-fuel production platform with no upstream exploration or downstream refining required.

Our advantages include the following.

Released under RTI Act - TMR

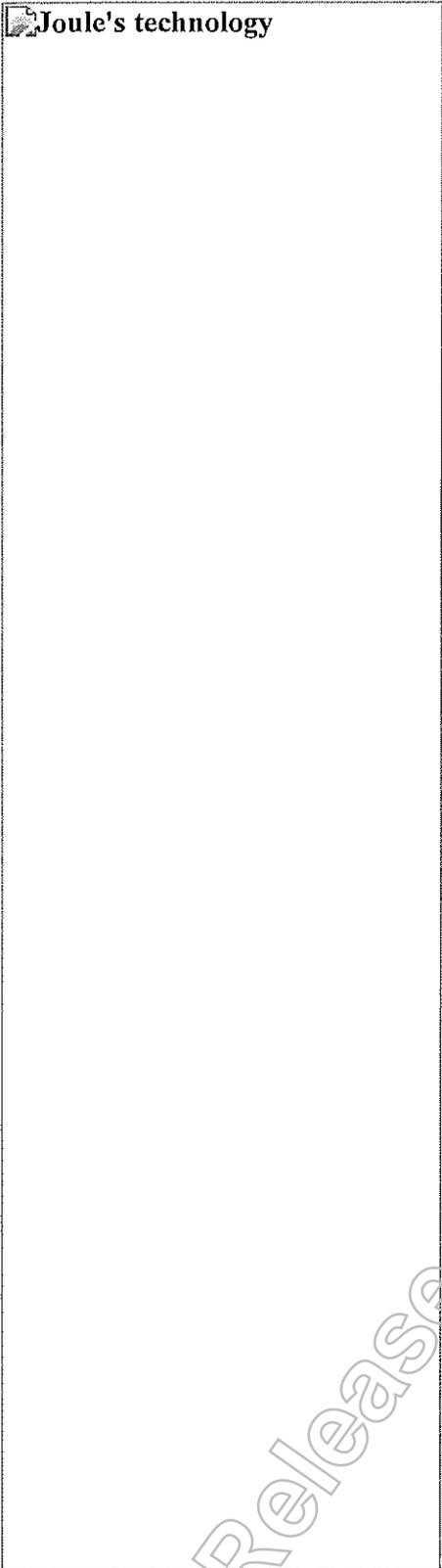

Joule's technology

Released under RTI Act - TMR

Conversion Technology Breakthroughs

Joule’s CO₂-to-liquids conversion technology is the first of its kind, applying product-specific bacteria to continuously convert waste CO₂ into targeted fuels or chemicals. These living catalysts are self-replicating before a “carbon switch” diverts nearly 100% of the carbon from cell growth to fuel production. We have developed a library of catalysts, each one optimized for production of a desired end product. In addition, our combined advances in catalyst engineering, solar capture and process engineering result in high CO₂-to-product conversion efficiency. For technical details, view a peer-reviewed research paper here.

Abundant Inputs, Valuable Outputs

Unlike fuels that are dependent on diminishing resources or process-intensive biomass, Joule’s process requires only sunlight, waste CO₂ and non-potable water, avoiding complex processing altogether. With

readily available low-cost feedstocks, our platform can be tailored to produce specific products simply by exchanging the catalyst. These products include infrastructure-ready ethanol and hydrocarbons for diesel, jet fuel and gasoline – all produced above ground with no “crude” intermediates or refining.

Modular, Scalable System

Joule plants feature a completely integrated production process, from catalyst construction to product generation, separation and storage. At the heart of this process is the modular *SolarConverter*[®] system, which enables direct conversion of CO₂ to fuels and chemicals in a single step. The system is designed for ease of installation and expansion in modular increments, making it readily scalable and customizable to targeted output levels based on solar insolation and availability of non-arable land, non-potable water and waste CO₂.

Efficient Production

Joule produces in minutes what conventional oil takes millions of years, avoiding the extreme complexity, volatile resources and escalating risks of fossil fuel production. At full-scale commercialization, a 10,000 acre Joule plant will produce a reserve value of 50 million barrels, equaling a medium-sized oil field. Yet unlike crude oil, Joule *Sunflow*[®] fuels require no upstream exploration or downstream refining.

Competitive Costs

The efficiencies of Joule’s process and system will allow us to meet or beat the costs of fossil fuels. We expect to deliver Joule *Sunflow*[®]-E and Joule *Sunflow*[®]-D for approximately \$1.20/US gallon (\$50/barrel).

Sustainability

With plentiful basic inputs, single-step production and a process that avoids depletion of precious natural resources, our platform represents the height of sustainability. And without feedstock or land constraints, our platform is suitable for deployment in many regions of the world, creating the opportunity to localize fuel production and reduce the burden of oil imports.

Robust Intellectual Property Portfolio

Spanning eight years of research and development, Joule has achieved many significant technical milestones related to our catalysts, process and site hardware. This results in the development of a broad-based, multifaceted IP estate covering core technologies and products, spanning the US, Europe, Australia, Mexico and China. We currently hold 64 patents and allowances, plus 95+ applications pending.

Attachments

- Joule-Products-2.jpg (48.55 KB)

Subject: ^_Fwd^_: ^_Material^_ to ^_support^_

From: [redacted] Sch 4 CTPI

To: mangocube6@yahoo.co.uk

Date: Tuesday, 10 November 2015 08:15:58 PM AEST

----- Forwarded message -----

From: **David Shankey** [redacted] Sch 4 CTPI

Date: Tue, Nov 10, 2015 at 8:15 PM

Subject: Material to support

To: [redacted] Sch 4 CTPI

Sch 3(6)(c)(i) Infringe the privileges of Parliament

Released under RTI Act - TMR

Pages 14 through 15 redacted for the following reasons:

Sch 3(6)(c)(i) Infringe the privileges of Parliament

Released under RTI Act - TMR

Subject: Community renewables development guide launched by Victorian govt | One Step Off The Grid

From: Sch 4 CTPI

To: mangocube6@yahoo.co.uk;

Date: Tuesday, 10 November 2015, 1:39

something Qld needs..

<http://onestepoffthegrid.com.au/community-renewables-development-guide-launched-by-victorian-govt/>

Community renewables development guide launched by Victorian govt

Victoria's community renewable energy sector got a boost this week with the state government's release of a guide to developing community owned-projects, as part of its upcoming Renewable Energy Action Plan.

State energy minister Lily D'Ambrosio launched the Guide to Community-Owned Renewable Energy for Victorians at the annual general meeting of Australia's first community-owned wind farm, Hepburn Wind, in Daylesford.

According to a media release, it will help local groups make informed decisions about establishing community renewable projects, including wind, solar, small-scale hydro, geothermal, bioenergy (from waste products) and energy storage technologies.

The guide also covers the development of sound business proposals, sources of possible funding (including crowdsourcing, grants and financing options), selecting the most suitable technologies, managing the project,

stakeholder consultation and connecting to the grid.

The news would be particularly welcome to wind energy developers, after a long drought in the sector caused by prolonged uncertainty at a federal level, combined with strict planning changes and a general lack of support at the state level, under the previous Liberal Baillieu/Napthine government.



And of course, wind energy is very competitive in the state. As we reported here, Victoria recently boasted the nation's lowest-cost wind farm, after Canberra-based Windlab secured a \$50 million financing deal for a 19.5MW wind farm in Coonooer Bridge, west of Bendigo.

The record breaking – and drought-breaking – project was one of three winners of a reverse auction held by the ACT government, delivering a locked in price of \$81.50 for 20 years.

Roger Price, the CEO of Windlab, says the project will deliver the cheapest wind energy in Australia, beating even the highly rated Snowtown projects owned by New Zealand firm TrustPower in South Australia.

“We’ve restarted renewable energy in Victoria, and now we’re committed to making our state the industry leader,” said D’Ambrosio at the launch on Monday. “That includes supporting community-owned projects.”

The guide – which will be the state’s first such community resource – has been welcomed by green groups and community energy advocates.

“(This) demonstrates an ‘all hands on deck’ approach to meet Victorian Renewable Energy Targets,” said Leigh Ewbank, Friends of the Earth’s renewable energy spokesperson.

“Government, industry, community and householders all have a role to play when it comes to growing renewable energy in Victoria and tackling climate change.”

Taryn Lane, from community energy group Embark, said the guide showed the Andrews government was proactively addressing the barriers faced by the Victorian community energy sector.

“We look forward to the government building on this step to help unlock community solar and wind projects,” Lane said.

The Andrews government is expected to release its full Renewable Energy Action Plan within weeks, which will – among other things – set Victoria’s renewable energy targets for 2020 and 2025.

In September, the Premier announced a baseline Victorian Renewable Energy Target of at least 20 per cent by 2020. Friends of the Earth and Embark expect the government to adopt more ambition in the final targets.

According to Ewbank, Victoria has enough shovel-ready wind farms and active communities “to smash the baseline target” by 2020.

“Ambitious Victorian Renewable Energy Targets will create jobs, unleash investment, and help tackle climate change. It’s something all political parties can support,” he said.

Attachments

- unnamed2.jpg (45.08 KB)
- hepburn-wind2.jpg (7.43 KB)

Released under RTI Act - TMR

Pages 19 through 21 redacted for the following reasons:

Sch 3(6)(c)(i) Infringe the privileges of Parliament

Released under RTI Act - TMR

Subject: Re: ^_Community^_^_renewables^_^_development^_^_guide^_^_launched by Victorian govt | One Step Off The Grid

From: Sch 4 CTPI

To: mangocube6@yahoo.co.uk

Date: Tuesday, 10 November 2015, 10:01:26 am AEST

It's a good election commitment.

On 10 Nov 2015, at 7:38 AM, Mark Bailey <mangocube6@yahoo.co.uk> wrote:

We should go this! M

Sent from my iPhone

Begin forwarded message:

From: Sch 4 CTPI

Date: 10 November 2015 at 1:39:39 AM AEST

To: Mark Bailey <mangocube6@yahoo.co.uk>

Subject: **Community renewables development guide launched by Victorian govt | One Step Off The Grid**

something Qld needs..

<http://onestepoffthegrid.com.au/community-renewables-development-guide-launched-by-victorian-govt/>

Community renewables development guide launched by Victorian govt

Released under RTI Act - TMR



Victoria's community renewable energy sector got a boost this week with the state government's release of a guide to developing community owned-projects, as part of its upcoming Renewable Energy Action Plan.

State energy minister Lily D'Ambrosio launched the Guide to Community-Owned Renewable Energy for Victorians at the annual general meeting of Australia's first community-owned wind farm, Hepburn Wind, in Daylesford.

According to a media release, it will help local groups make informed decisions about establishing community renewable projects, including wind, solar, small-scale hydro, geothermal, bioenergy (from waste products) and energy storage technologies.

The guide also covers the development of sound business proposals, sources of possible funding (including crowdsourcing, grants and financing options), selecting the most suitable technologies, managing the project, stakeholder consultation and connecting to the grid.

The news would be particularly welcome to wind energy developers, after a long drought in the sector caused by prolonged uncertainty at a federal level, combined with strict planning changes and a general lack of support at the state level, under the previous Liberal Baillieu/Napthine government.

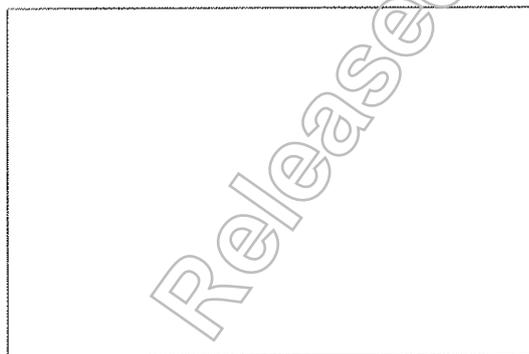

And of course, wind energy is very competitive in the state. As we reported [here](#), Victoria recently boasted the nation's lowest-cost wind farm, after Canberra-based Windlab secured a \$50 million financing deal for a 19.5MW wind farm in Coonooer Bridge, west of Bendigo.

The record breaking – and drought-breaking – project was one of three winners of a reverse auction held by the ACT government, delivering a locked in price of \$81.50 for 20 years.

Roger Price, the CEO of Windlab, says the project will deliver the cheapest wind energy in Australia, beating even the highly rated Snowtown projects owned by New Zealand firm TrustPower in South Australia.

"We've restarted renewable energy in Victoria, and now we're committed to making our state the industry leader," said D'Ambrosio at the launch on Monday. "That includes supporting community-owned projects."

The guide – which will be the state's first such community resource – has been welcomed by green groups and community energy advocates.

"(This) demonstrates an 'all hands on deck' approach to meet Victorian Renewable Energy Targets," said Leigh Ewbank, Friends of the Earth's renewable energy spokesperson.

"Government, industry, community and householders all have a role to play when it comes to growing renewable energy in Victoria and tackling climate change."

Taryn Lane, from community energy group Embark, said the guide showed the Andrews government was proactively addressing the barriers faced by the Victorian community energy sector.

"We look forward to the government building on this step to help unlock community solar and wind projects," Lane said.

The Andrews government is expected to release its full Renewable Energy Action Plan within weeks, which will – among other things – set Victoria's renewable energy targets for 2020 and 2025.

In September, the Premier announced a baseline Victorian Renewable Energy Target of at least 20 per cent by 2020. Friends of the Earth and Embark expect the government to adopt more ambition in the final targets.

According to Ewbank, Victoria has enough shovel-ready wind farms and active communities "to smash the baseline target" by 2020.

"Ambitious Victorian Renewable Energy Targets will create jobs, unleash investment, and help tackle climate change. It's something all political parties can support," he said.

Released under RTI Act - IMP

Subject: Re: QUU
From: Peter Simpson (ETU) (<simmo@etu.org.au>)
To: mangocube6@yahoo.co.uk;
Date: Wednesday, 11 November 2015, 18:35

Ok mate cheers

Regards,

Peter Simpson
State Secretary
Electrical Trades Union
Queensland
M. NR
F. (07) 3844 9851
simmo@etu.org.au
www.etu.org.au

Join Online
www.etuyes.com
Or call
1800ETUYES

Disclaimer

The information contained in the e-mail is intended only for the use of the person(s) to whom it is addressed and may be confidential or contain legally privileged information. If you are not the intended recipient you are notified that any perusal, use, distribution, copying or disclosure is strictly prohibited. If you have received this e-mail in error please immediately advise us by return e-mail and delete the e-mail document without making a copy.

On 11 Nov 2015, at 6:12 PM, Mark Bailey <mangocube6@yahoo.co.uk> wrote:

Got to it fully a bit earlier... Chat with you bit later about it. Haven't kicked it on just yet. M

Sent from my iPhone

On 11 Nov 2015, at 3:22 PM, Peter Simpson (ETU) <simmo@etu.org.au> wrote:

So reading the tea leaves our side our boys want it outsourced do they can get paid correctly, bizarre but a sad reflection on council wages

Sent from my iPhone

On 11 Nov 2015, at 3:02 PM, Mark Bailey <mangocube6@yahoo.co.uk> wrote:

Thx Simmo. Haven't got to Harding or Milton just yet.
Sent from my iPhone

On 11 Nov 2015, at 1:15 PM, Peter Simpson (ETU)
<simmo@etu.org.au> wrote:

Mate,

Read below, a bit more to this than first appeared

From: Scott R
Sent: Wednesday, 11 November 2015 12:23 PM
To: Peter Simpson (ETU) <simmo@etu.org.au>; Brenton Muller <brenton@etu.org.au>
Subject: RE: QUU

This has been in the pipeline for a while. Our members will be \$400/week better off. Its probably going to Downer who have already done an agreement with us.

When they moved to the federal system they no longer have an agreement we can rely on to stop it and they have been pricks thru 2 elections already despite being owned by 5 councils. The media does not care. The councillors claim it will be lower water costs so media will crucify any of ours that come out against it.

Our members all want this to happen now given the benefits of government ownership disappeared under Newman and then due to QR decision and now they stand to be paid market rates - as I said minimum \$400 week more than what they are paid now. Along with redundancy payment from QUU and CIRT in the new agreement

While the principle against outsourcing remains the same, these guys have been fucked around being 'publically owned' enough that they are happy to be in the private sector and paid market rates.

Gimme a call if you want to discuss further.

Cheers,

Scott Reichman
Organiser
Electrical Trades Union QLD & NT

NR

sjr@etu.org.au
www.etu.org.au

Capitalism is the extraordinary belief that the greediest of men with the nastiest of motives will somehow work for the benefit of all.

From: Peter Simpson (ETU)
Sent: 11/11/2015 11:22
To: brenton@etu.or.au; Scott R
Subject: QUU

Comrades,

Just had a tip off that QUU are looking at outsourcing ALL jobs. As BCC owns 80%, if we can get some more guts on that we'll be able to nullify it fairly quickly I'd suggest, given the upcoming council elections

Can you do some digging, see what you can find out on the grapevine and then come back to me please, we obviously need to put together a short sharp campaign to expose this, once we have a bit more. The tip came from a very reliable source, albeit without any detail

Simmo

Regards,

Peter Simpson

State Secretary

NR

simmo@etu.org.au

Released under RTI Act - TMR

Subject: FYI Queensland legislation against Federal radioactive waste facilities.....
From: Dave Sweeney (D.Sweeney@acfonline.org.au)
To: mangocube6@yahoo.co.uk;
Date: Sunday, 15 November 2015, 14:50

Hi Mark – fyi and consideration ahead of discussions tomorrow.

What the Feds are proposing is precluded under existing Qld law – the Qld Nuclear Facilities Prohibition Act 2007

See: <http://legislation.qld.gov.au/LEGISLTN/ACTS/2007/07AC004.pdf>

<http://www.theage.com.au/news/National/New-law-bans-nuclear-power-in-Qld/2007/05/02/1177788192581.html>

The Act makes the construction of a nuclear waste storage facility unlawful – the schedule/dictionary definition in S 6 clearly captures what is being proposed by Canberra as it both includes radioactive waste as nuclear material and explicitly refers to reactor arisings (d) – whether for power or otherwise.

Should the Feds continue to push such a facility the Act requires the Qld Govt - s.22 (3) – to hold a state plebiscite on the issue ‘to obtain the views of the people of Qld’

I don’t think Minister Frydenburg would be overly keen on this.....

Happy to discuss – solidarity and best,

Dave



**AUSTRALIAN
CONSERVATION
FOUNDATION**

Dave Sweeney
Nuclear Free Campaigner
Australian Conservation Foundation
Level 1 - 60 Leicester Street, CARLTON VIC 3053, Australia
Ph +61 3 9345 1130 Mob + NR Fax +61 3 9345 1166
d.sweeney@acfonline.org.au

www.acfonline.org.au
[@AusConservation](#) [facebook](#)

ACF is celebrating our first 50 years! Heartland is a book of words and photos commemorating ACF's birthday and our work protecting life in this beautiful country. Available at good bookstores and online.

This email and any files transmitted with it may be confidential and legally privileged. If you are not the intended recipient of this email, you must not disclose or use the information contained in it. If you have received this email in error, please notify us by return email and permanently delete the document.

We acknowledge the Traditional Owners of this country and their continuing connection to land, waters and community. We pay respect to their elders past and present and to the pivotal role that Aboriginal and Torres Strait Islander people continue to play in caring for country across Australia.

Message protected by MailGuard: e-mail anti-virus, anti-spam and content filtering.
<http://www.mailguard.com.au/mg>

Released under RTI Act - TMR

Subject: Re: ^_Dept^_ ^_Query^_

From: Tam.VanAlphen@ministerial.qld.gov.au

To: mangocube6@yahoo.co.uk

Date: Monday, 16 November 2015 11:26:51 PM AEST

Sure thing - nothing attached from what I can tell but will get off you tomorrow

Sent from my iPhone

> On 16 Nov 2015, at 10:18 pm, Mark Bailey <mangocube6@yahoo.co.uk> wrote:
>

> Sch 4 CTPI sent this in... Cld u flick it to do for follow up please? Thx... M ps it's off Facebook so I'll get his email

>

> Sent from my iPhone

This email, together with any attachments, is intended for the named recipient(s) only; and may contain privileged and confidential information. If received in error, you are asked to inform the sender as quickly as possible and delete this email and any copies of this from your computer system network.

If not an intended recipient of this email, you must not copy, distribute or take any action(s) that relies on it; any form of disclosure, modification, distribution and /or publication of this email is also prohibited.

Unless stated otherwise, this email represents only the views of the sender and not the views of the Queensland Government.

Please consider the environment before printing this email.

Released under RIPA Act - IMR

Subject: ASF
From: Sch 4 CTPI
To: mangocube6@yahoo.co.uk;
Date: Thursday, 19 November 2015, 14:23

Mark

Thank you for your time on the phone last night.

Please see the letter I referred to attached. The previous government confirmed they would only offer ASF a gaming license if there was a binding agreement from ASF to build a cruise ship terminal.

We would expect that now that cruise ship terminal is not going ahead that there will be no gaming license offered.

kind regards,

Sch 4 CTPI

Attachments

- ASF - Binding agreement infrastructure for gaming license.pdf (1.43 MB)

Released under RTI Act - 2008



Hon Jeff Seeney MP
Deputy Premier

Minister for State Development, Infrastructure and Planning

13/2/14

12 February 2014

Mr Tom Tate
Mayor
City of Gold Coast
PO Box 5042
GOLD COAST MAIL CENTRE QLD 9729

	Paper No.: S44LT 4501	
	Date: 13/2/14	
	Member: Hon Seeney	
Tabled	Tabled, by leave	
Incorporated, by leave	Remainder incorporated, by leave	
Clerk at the Table:		

Dear *Tom* Tate,

In November 2012 the State Government entered into a MOU with the GCCC to investigate a proposal you had initiated as a successful Mayoral candidate to establish a cruise ship terminal in the Southport Broadwater.

Under the MOU, the State Government committed to making State Land adjoining the Broadwater available for development by the private sector on commercial terms to be agreed if the development could lead to the successful establishment of the cruise ship terminal you were promoting.

The assessment of private sector proposals submitted as part of the Request for Detailed Proposals process and carried out jointly by officers of my Department and your Council is now complete and I write to clarify the next steps that are required by the State Government for the State land to be made available for development.

The joint assessment panel has assessed all submitted proposals and identified one possible proponent to undertake the development of a cruise ship terminal in the Broadwater. This possible proponent is the ASF Consortium.

The comprehensive assessment has confirmed that, while it would be technically possible to establish a cruise ship terminal in the Broadwater, further detailed work is needed by your Council and the identified possible proponent to ensure any development is supported by the general public, is environmentally and economically sustainable, and would not pose a burden on existing infrastructure.

Level 12 Executive Building
100 George St Brisbane
PO Box 15009 City East
Queensland 4002 Australia
Telephone +61 7 3222 4600
Facsimile +61 7 3210 2185
Email duphys@mineralsandinfrastructure.qld.gov.au

The analysis undertaken by the joint assessment panel has shown that the extensive capital and operational costs of the terminal and associated dredging would need to be extensively cross-subsidised by income derived from other developments.

The proposal submitted by ASF Consortium reflects this conclusion and has identified large scale residential and resort development, together with a casino, as being necessary to cross-subsidise the construction and operational cost of a cruise ship terminal.

The scale of the development being proposed by ASF Consortium has the potential to have considerable impact on existing business and property markets. It would therefore be necessary for GCCC to undertake extensive community consultation and provide the State Government with an indication of the extent of community support before State land would be made available.

Independent expert consultants contracted by the Assessment Panel have identified a number of other issues that need to be addressed before the project should proceed further.

Foremost amongst these issues is the need to conduct preliminary environmental studies to update outdated information available in regard to the impacts of the capital and maintenance dredging that would be necessary for cruise ships to access the Broadwater. These preliminary environmental studies are considered necessary to inform the lodgement of an initial advice statement with the Coordinator General and the development of terms of reference for a full environmental impact study (EIS).

The Gold Coast City Council in conjunction with the possible proponent would need to fund and complete these preliminary environmental studies as well as address the other outstanding issues identified by the independent consultants during the assessment process to date. A complete list of those issues, as advised by my Department, is attached.

In relation to the requirement for a casino licence, my Department is currently conducting an Expression of Interest (EOI) process for the allocation of gaming licences to complement the successful establishment of internationally-competitive Integrated Resort Developments in Queensland.

The possible proponents identified for the Broadwater cruise ship terminal development are free to lodge a Registration of Interest for the EOI process. It is expected that, if ASF Consortium is successful in obtaining a casino license under this process, a binding agreement would be reached that any gaming licence granted would be conditional on the prior establishment and ongoing operation of a successful cruise ship terminal.

However, the issue of a temporary casino licence will not be considered, and this will need to be addressed as part of the proposal.

In summary, the State Government maintains its initial position of offering to make State land available on agreed commercial terms for the private sector to develop a cruise ship terminal in the Southport Broadwater provided there is no ongoing cost or risk to the State.

Additionally, I advise that if you and the GCCC seek to further advance your proposal for a Cruise Ship Terminal in the Broadwater you will need to:

- undertake extensive community consultation and provide evidence of the degree of public support for the scale of development proposed at the Broadwater
- work with the possible proponent to conduct preliminary environmental studies to update the information available in regard to the impacts of the capital and maintenance dredging that would be necessary for cruise ships to access the Broadwater
- work with the possible proponent to address shortcomings in infrastructure network planning
- address all other outstanding issues identified in attachment 1.

My Department and I will be happy to continue discussions on how these issues might be addressed by either your Council or the identified possible proponent to ensure the State land can be made available for the cruise ship terminal proposition put forward by the GCCC.

I wish you well with the further development of your cruise ship terminal proposal.

Yours sincerely,



JEFF SEENEY

DEPUTY PREMIER

Minister for State Development, Infrastructure and Planning

**ROLES AND RESPONSIBILITIES TO IDENTIFY AND ADDRESS ALL
OUTSTANDING RISKS AND ISSUES**

Queensland Government (Government)

1. Government proactively releases all independent technical reports and information (with the exception of commercial and cabinet-in-confidence documents) made available to shortlisted Request for Detailed Proposals (RFDP) proponents in the Broadwater Marine Project dataroom in addition to this paper (only in the event Council and ASF Consortium wish to pursue a Broadwater Cruise Ship Terminal (CST)) to publicly address the complexity and breadth of technical issues of establishing a Broadwater CST.
2. Should Gold Coast City Council (Council) and ASF Consortium address all outstanding environmental and technical issues, demonstrate strong community support and develop a plan to gain all necessary approvals for the CST, Government will honour its commitment to consider the allocation of State land.

Gold Coast City Council (Council)

1. Council immediately undertakes a community consultation process with ASF Consortium seeking public comment and support for ASF Consortium's Development Concept in accordance with the Request for Detailed Proposals (RFDP).
2. Council considers the feedback received from the community consultation process and demonstrates community support for the project.
3. Council works with ASF Consortium to assist resolution of ASF Consortium's specified conditions precedent and caveats.

ASF Consortium

1. ASF Consortium works with Council to assist resolution of Council's specified conditions and caveats.
2. In addition to resolving the conditions precedent nominated in ASF Consortium's detailed proposal, ASF Consortium refines its Detailed Proposal to resolve the nominated issues listed below.

Technical and Environmental

3. A more detailed Preliminary Environmental Assessment is prepared to inform the initial design process. Historical EIS data should not be solely relied upon to inform the preparation of an Initial Advice Statement.
4. A detailed assessment of the demand for power to inform assessment of the impacts on the trunk power network and measures to mitigate the impacts is prepared.
5. A detailed assessment of the demand for water/sewer and their impacts on the trunk water/sewer network and the existing and planned Recycled Water Release Systems is prepared.
6. A detailed assessment of the traffic generation to include traffic arising from the cruise ship operations and the development and modelling of the baseline 'without development' and 'with development' scenarios is prepared. This is to better understand the impacts of the development on the trunk land transport network.
7. A detailed assessment of the impacts of the dredging works associated with the CST, together with the reclamation works within the proposed development is to be prepared.
8. A contingency plan for adverse weather events of a scale that would disrupt the operations of the CST is prepared to ensure the ongoing operation of the CST.

Development Concept

9. The Development Concept is refined to fully comply with the State's tenure conditions as prescribed in the BMP Request for Detailed Proposals documentation.
10. The Development Concept is refined to remove the proposal for a staged casino land use development.
11. The scale of the proposed project components is more fully justified. Current staging plan outlines significant market and delivery risk because of a reliance on back-ended cash flows.
12. The suitability of guarantees relating to market and delivery risk is more fully justified. The allocated performance bond is meritorious but further evaluation is required to determine if this is sufficient to resolve issues associated with the Project Staging Plan. In addition, assumed linkages with sovereign entities need clarification.
13. An appropriate strategy to manage associated shifts of related demographics, potentially high vacancies, international tourism and impacts on activation and retail spending in order to justify the significant volume of residential product that is to be sold internationally is prepared.

14. An appropriate strategy for the ongoing management of the CST is structured that responds to the State's condition that an operational casino license may only be granted on the provision of an ongoing operational CST.
15. The requirement to grant a holding over both The Spit and Wavebreak Island is more fully justified.
16. A detailed assessment of each land use component (e.g. mix, inventories, integration, staging) is prepared.
17. A detailed assessment of local market drivers, office space and rents, retail space and rents to guarantee deliverability is prepared.
18. A detailed assessment of international tourism market drivers -- international currency fluctuation, cruise shipping trends including the impact on the proposal of the introduction of larger vessels currently being planned -- to guarantee operability is prepared.
19. A CST operating entity is identified and secured.

Subject: Greetings Mark - sending this intro brief to affected Mayor and Councillors - thought some content might be of use/interest to you - thanks and best,
From: Dave Sweeney (D.Sweeney@acfonline.org.au)
To: mangocube6@yahoo.co.uk;
Date: Friday, 20 November 2015, 12:57

I write in relation to the recent national radioactive waste site nomination in your Council region.

Clearly there are community concerns about these proposals and I write to both convey ACF's view on the site nomination process and the imminent return of radioactive waste to NSW and to also let you know that ACF is happy to provide information and context to Council or any other stakeholders about any of these issues, especially during the current consultation period.

I am familiar with the federal governments siting process through my involvement with the Department's Independent Advisory Panel and have been closely tracking radioactive waste management issues in recent years – including working with the community in relation to the earlier proposal for a comparable facility at Muckaty in the NT.

Also find a link to a recent short radio piece which provides a snapshot of ACF's view:
<http://www.nirs.org.au/NEWS/Proposals-for-a-national-nuclear-waste-dump-sparks-call-for-review>

Please feel free to contact me on d.sweeney@acfonline.org.au or NR to discuss any aspect of the current radioactive waste siting and management process or discourse.

All best wishes,

Dave Sweeney

- (i) **ACF's view on the current national radioactive waste site nomination process.**

No need to rush on radioactive waste

The federal government's recent announcement that six sites in regional Australia are being considered to host a national radioactive waste facility has understandably generated much attention and concern.

The government's plan involves the shallow burial of low-level radioactive waste and above ground storage, in sheds, of long lived higher level waste. There is no intention to ever recover the low level material, while

there are plans to remove and bury the higher level waste after a period of 100 to 300 years.

The employment and economic opportunities provided by the plan are modest. There would be some short term trenching, fencing and construction work (most likely by an external contractor) and there are plans for six ongoing security and maintenance jobs, plus a 'community fund' of no more than ten million dollars (with no clear guidance on where, when or how the government – not the community – uses this money).

Radioactive waste hangs around for thousands of years. So its management demands the highest quality decision making and information. Regional communities would do well to scrutinise the fine print and ask the hard questions during the current consultation period.

Previous federal attempts over many years to force a national nuclear waste dump on multiple sites in regional South Australia and the Northern Territory have all failed, so the Turnbull government's commitment not to impose radioactive waste storage on unwilling communities is important and welcome.

Further good news is that there is no need to rush any decision as around 95% of the radioactive waste slated for any future national facility is currently securely stored at two dedicated federal sites.

Australian radioactive waste now returning from treatment in Europe is set to go back to where it was produced – the Australian Nuclear Science and Technology Organisation's Lucas Heights reactor facility. ANSTO and the federal nuclear regulator have confirmed it can remain there for decades.

Environment, public health, Indigenous and trade union groups have long called for an expert, open and independent Inquiry into the full range of waste management options.

Sadly, this approach has been ignored by successive federal governments. With regional concerns high and no compelling social, health or technical reasons to rush, a genuine review would be the best way to identify and advance lasting and responsible radioactive waste management options.

ACF strongly maintains that this is an opportunity we literally cannot afford to waste.

(ii) ACF's view on the return of reprocessed spent nuclear fuel for storage at ANSTO's Lucas Heights nuclear facility:

The *BBC Shanghai* left the French port of Cherbourg in mid-October carrying twenty five tonnes of Australian origin long lived intermediate level waste returning here after reprocessing in France.

There has been controversy about the shipment, including safety and capacity concerns raised by Greenpeace about the vessel and a statement from the Indonesia's Maritime Security Board that it can not

pass through Indonesian waters. There is sure to be more domestic and international media attention when it arrives in Port Kembla (Wollongong), expected to be in early December.

After arrival in Kembla the waste – which is in solid form inside a special transport container – will be moved by road to the Australian Nuclear Science and Technology Organisation's Lucas Heights reactor facility in southern Sydney.

ACF along with many in the wider national environment and nuclear free movements and key civil society partners maintain that extended interim storage at Lucas Heights is the current least worst management option, as:

- ANSTO is already both the continuing producer of and home to the vast majority of Australia's higher level radioactive waste
- ANSTO has certain tenure, a secure perimeter and is monitored 24/7 by Australian federal police
- Storing the waste at ANSTO means the waste will be actively managed as operations at the site are licensed for a further three decades – it also keeps waste management on the radar of the facility/people with the highest concentration of nuclear expertise and radiation response capacity in Australia
- Since the government realised in 2012 that the planned national waste dump at Muckaty would not be in place prior to the return of this waste, ANSTO has constructed and commissioned a new purpose built on site storage shed dedicated to housing this waste
- Extended interim storage at ANSTO helps reduce the political pressure to rush to find a 'remote' out of sight, out of mind dump site and increases the chances of advancing responsible management
- Storage at ANSTO has been publicly identified as a credible and feasible option by ANSTO, the nuclear industry lobby group, the Australian Nuclear Association and the federal nuclear regulator, the Australian Radiation and Nuclear Safety Agency (ARPANSA)

Importantly, this approach also provides the ability to have a circuit breaker in this long running issue in the form of an evidence based and open review of the best longer term management options.

Nothing about the nuclear industry, especially nuclear waste, is clean or uncomplicated but we view extended interim storage as the least worst approach and one - that if coupled with a wider public review of the full range of longer term management options - is most likely to advance responsible radioactive waste management.



**AUSTRALIAN
CONSERVATION
FOUNDATION**

Dave Sweeney
Nuclear Free Campaigner
Australian Conservation Foundation
Level 1 - 60 Leicester Street, CARLTON VIC 3053, Australia
Ph +61 3 9345 1130 Mob NR Fax +61 3 9345 1166

d.sweeney@acfonline.org.au

www.acfonline.org.au

[@AusConservation](#) [facebook](#)

ACF is celebrating our first 50 years! Heartland is a book of words and photos commemorating ACF's birthday and our work protecting life in this beautiful country. Available at good bookstores and online.

This email and any files transmitted with it may be confidential and legally privileged. If you are not the intended recipient of this email, you must not disclose or use the information contained in it. If you have received this email in error, please notify us by return email and permanently delete the document.

We acknowledge the Traditional Owners of this country and their continuing connection to land, waters and community. We pay respect to their elders past and present and to the pivotal role that Aboriginal and Torres Strait Islander people continue to play in caring for country across Australia.

Message protected by MailGuard: e-mail anti-virus, anti-spam and content filtering.
<http://www.mailguard.com.au/mg>

Released under RTI Act TMR

Subject: Pic EVP

From: mangocube6@yahoo.co.uk

To: mangocube6@yahoo.co.uk

Date: Sunday, 22 November 2015, 11:45:08 am AEST

Sent from my iPhone



IMG_9528.JPG
156.9kB

Released under RTI Act - TMR



Subject: EVP 2

From: mangocube6@yahoo.co.uk

To: mangocube6@yahoo.co.uk

Date: Sunday, 22 November 2015, 11:57:23 am AEST

Sent from my iPhone



IMG_9527.JPG
227.2kB

Released under RTI Act - TMR

Sch 4 CTPI

Sch 4 CTPI

Released under RTI Act - TMR

Subject: ^_EVP^_^_3^_

From: mangocube6@yahoo.co.uk

To: mangocube6@yahoo.co.uk

Date: Sunday, 22 November 2015, 11:57:46 am AEST

Sent from my iPhone



IMG_9530.JPG
55.7kB

Released under RTI Act - TMR

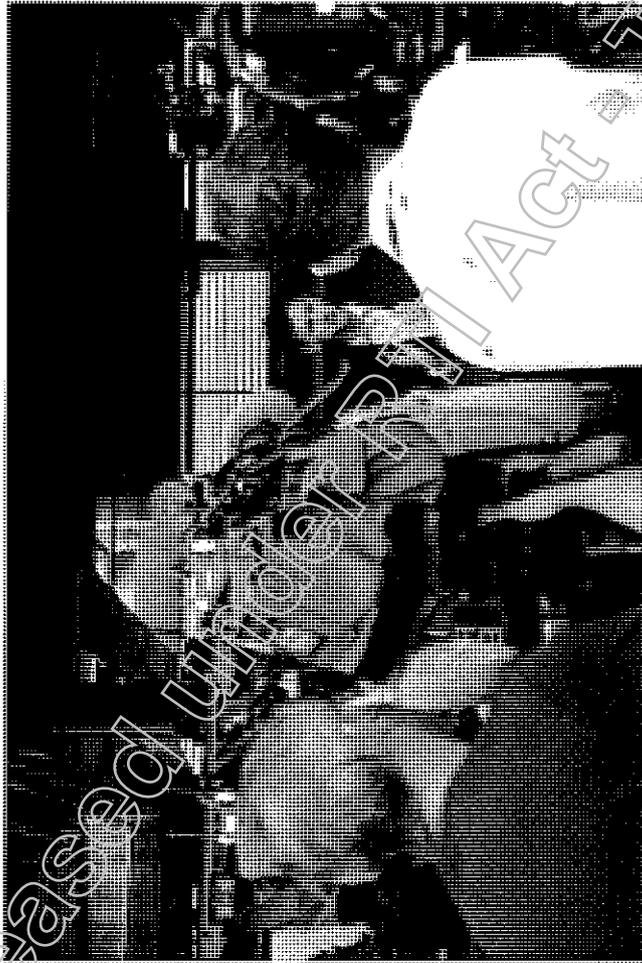

Subject: Evp4

From: mangocube6@yahoo.co.uk

To: mangocube6@yahoo.co.uk

Date: Sunday, 22 November 2015, 11:58:06 am AEST

Sent from my iPhone



IMG_9526.JPG
160.5kB

Released under RTI Act - TMR

Emergency Paramedics

Sch 4 CTPI

Released under RTI Act - TMR

Subject: ^_Fwd^_: ^_Stanwell^_ ^_media^_ ^_statement^_ re: ^_incident^_ at
^_Tarong^_

From: Mark.Bailey@ministerial.qld.gov.au

To: mangocube6@yahoo.co.uk

Date: Sunday, 29 November 2015 04:52:15 PM AEST

Sent from my iPhone

Begin forwarded message:

From: Denise Spinks <Denise.Spinks@ministerial.qld.gov.au>
Date: 29 November 2015 at 2:03:41 PM AEST
To: Tim Shipstone <Tim.Shipstone@ministerial.qld.gov.au>, David Shankey <David.Shankey@ministerial.qld.gov.au>, Mark Bailey <Mark.Bailey@ministerial.qld.gov.au>
Subject: Fwd: Stanwell media statement re: incident at Tarong

Fyi

Sent from my iPhone

Begin forwarded message:

From: "Kelly, Rebecca" <Rebecca.KELLY@stanwell.com>
Date: 29 November 2015 at 1:28:37 PM AEST
To: "Denise Spinks (Denise.Spinks@ministerial.qld.gov.au)" <Denise.Spinks@ministerial.qld.gov.au>, "Jason.humphreys@ministerial.qld.gov.au" <Jason.humphreys@ministerial.qld.gov.au>
Cc: "Merritt, Jay" <Jay.Merritt@stanwell.com>
Subject: Stanwell media statement re: incident at Tarong

Hi Denise and Jason

As per my earlier phone call, please find attached a copy of the Stanwell/UGL media statement in relation to the fatality today at Tarong power station.

If you have any questions, please give myself or Jay a call.

Kind Regards
Rebecca

Rebecca Kelly
Corporate Communication Manager
Community and Stakeholder Engagement

mobile NR direct +61 7 3335 3836

Level 13, 42 Albert Street

GPO Box 800, Brisbane, QLD 4001 [stanwell.com](http://www.stanwell.com)

This email is to be read subject to the email disclaimer located at <http://www.stanwell.com/site-information/email-disclaimer/>

This email, together with any attachments, is intended for the named recipient(s) only; and may contain privileged and confidential information. If received in error, you are asked to inform the sender as quickly as possible and delete this email and any copies of this from your computer system network.

If not an intended recipient of this email, you must not copy, distribute or take any action(s) that relies on it; any form of disclosure, modification, distribution and /or publication of this email is also prohibited.

Unless stated otherwise, this email represents only the views of the sender and not the views of the Queensland Government.

Please consider the environment before printing this email.



Media statement - 29 November 2015.doc
453.5kB



ATT00001.htm
334B

Released under RPA Act - EMR

MEDIA RELEASE

29 November 2015

A fatality has occurred involving a delivery driver at the Tarong power stations earlier this morning.

Queensland Police and emergency services are in attendance.

Stanwell and UGL are devastated for the family, friends and work mates of the delivery driver.

Stanwell and UGL will do everything it can to assist the family, its employees and contractors during this time.

Counselling support is being arranged for those directly and indirectly involved.

Stanwell and UGL are working closely with all relevant authorities to investigate this tragedy.

Further information will be provided as it becomes available.

All media enquiries should be directed to Queensland Police on 3015 2444.

Background:

UGL Limited (UGL) provides facility management, overhaul, asset and maintenance management (FOAMM) services at the Tarong power stations.

Released under RTI Act - TMR

Subject: Re: Stanwell media statement re: incident at Tarong
From: Peter Simpson (ETU) (simmo@etu.org.au)
To: mangocube6@yahoo.co.uk;
Date: Sunday, 29 November 2015, 18:31

Ta mate

Sent from my iPhone

On 29 Nov 2015, at 6:29 PM, Mark Bailey <mangocube6@yahoo.co.uk> wrote:

FYI... M

Sent from my iPhone

Begin forwarded message:

From: Denise Spinks <Denise.Spinks@ministerial.qld.gov.au>
Date: 29 November 2015 at 2:03:41 PM AEST
To: Tim Shipstone <Tim.Shipstone@ministerial.qld.gov.au>, David Shankey <David.Shankey@ministerial.qld.gov.au>, Mark Bailey <Mark.Bailey@ministerial.qld.gov.au>
Subject: Fwd: Stanwell media statement re: incident at Tarong

Fyi

Sent from my iPhone

Begin forwarded message:

From: "Kelly, Rebecca" <Rebecca.KELLY@stanwell.com>
Date: 29 November 2015 at 1:28:37 PM AEST
To: "Denise Spinks (Denise.Spinks@ministerial.qld.gov.au)" <Denise.Spinks@ministerial.qld.gov.au>, "Jason.humphreys@ministerial.qld.gov.au" <Jason.humphreys@ministerial.qld.gov.au>
Cc: "Merritt, Jay" <Jay.Merritt@stanwell.com>
Subject: Stanwell media statement re: incident at Tarong

Hi Denise and Jason

As per my earlier phone call, please find attached a copy of the Stanwell/UGL media statement in relation to the fatality today at Tarong power station.

If you have any questions, please give myself or Jay a call.

Kind Regards
Rebecca

Rebecca Kelly

Corporate Communication Manager

Community and Stakeholder Engagement

mobile NR direct +61 7 3335 3836

Level 13, 42 Albert Street

GPO Box 800, Brisbane, QLD 4001 stanwell.com

This email is to be read subject to the email disclaimer located at
<http://www.stanwell.com/site-information/email-disclaimer/>

This email, together with any attachments, is intended for the named recipient(s) only; and may contain privileged and confidential information. If received in error, you are asked to inform the sender as quickly as possible and delete this email and any copies of this from your computer system network.

If not an intended recipient of this email, you must not copy, distribute or take any action(s) that relies on it; any form of disclosure, modification, distribution and /or publication of this email is also prohibited.

Unless stated otherwise, this email represents only the views of the sender and not the views of the Queensland Government.

Please consider the environment before printing this email.

<Media statement - 29 November 2015.doc>

Subject: Fwd: Sunland - Spit land - DNRM Delegated Authority?

From: Sch 4 CTPI

To: Mangocube6@yahoo.co.uk;

Date: Monday, 30 November 2015, 19:51

Hi

I sent this to your work email today...
thanks

Sch4 CTPI

----- Forwarded message -----

From: Sch 4 CTPI

Date: 30 November 2015 at 13:11

Subject: Fwd: Sunland - Spit land - DNRM Delegated Authority?

To: mainroads@ministerial.qld.gov.au

Hon. Mark Bailey,

Please find attached a letter confirming the change of use agreement made by DNRP to Sunland for the Spit land on 4 July 2014. As you can see below, I have contacted Andrew Cripps to confirm this was in fact done by Delegated Authority. I can't imagine how this was proper process (to authorise without input from either the then minister or the GCCC) given the significance of this change for the Gold Coast.

How do I find out if due process was in fact undertaken or not?

kind regards

Sch 4 CTPI

Sch 4 CTPI

Connect on Linked-In

m NR

----- Forwarded message -----

From: Sch 4 CTPI

Date: 30 November 2015 at 12:56

Subject: Sunland - Spit land - DNRM Delegated Authority?

To: hinchinbrook@parliament.qld.gov.au

Dear Andrew,

I am doing some investigating into the approval process far for the Sunland Spit lease. John-Paul Langbroek provided me the attached document which confirms the DNRM approved the amendment of the lease to

include the operation of residential accommodation and reclamation without any input for the Gold Coast City Council on 4 July 2014.

John-Paul thought you were not made aware of this decision at the time. Instead it was made by Delegated Authority by a public servant within DNRM. Could you please confirm if this is in fact the case? If so, would you have any record/ recollection of who made the Deleated Authority and why they were provided the authority to do this without seeking any comment from the Gold Coast City Council?

kind regards

Sch 4 CTPI

Sch 4 CTPI

Connect on Linked-In

m NR

Attachments

- Sunland DA30112015.pdf (541.64 KB)

Released under RTI Act - TMR

7. 9. 15

CITY OF
GOLDCOAST.**Memorandum**

To: Councillor AJD (Lex) Bell
 Copy: His Worship the Mayor
 All Councillors
 From: Dyon Currie – Director Planning and Environment
 Actioned by: Michael Moran – Acting Executive Coordinator Major Assessment
 Subject: Sunland Development Application MCU201500720

Lot 90 on WD839540 : 60 Seaworld Drive, Main Beach
 Lot 524 on WD8023 : 64 Seaworld Drive, Main Beach

Date: 7 September 2015

File no: PN60340/13/DA7

Doc #: 50830364

Dear Councillor Bell,

Reference is made to your Memorandum dated 4 August 2015 in relation to Sunland's 'Mariner's Cove' development application.

In 2012, Sunland became the Registered Lessee under Dealing No. 714231330 for Special Lease No. 52285, which is subject to a 75 year lease commencing on 01/05/1992 and expiring on 30/04/2067.

In June 2013, Sunland lodged an application with the Department of Natural Resources and Mines (DNRM) for a 'Change of Purpose of a Lease' over the subject site. The request was for an amendment to the use of the leased land for commercial/business purposes for the operation of a tourism facility, marina facility, residential accommodation and reclamation as well as a request for the removal of the condition stating that the Lease is not eligible for conversion to either freehold or perpetual lease tenure.

On 4 July 2014, DNRM approved Sunland's requested changes to the purpose of the lease, but did not approve the request for the removal of the condition that prohibits the conversion of the lease (refer to conditions A78(1) and G61 of Special Lease No 52285 attached).

Officers are of the understanding that the abovementioned application was processed by DNRM without comment from Council.

Officers have noted the 2003 Council Resolution (G03.0803.008), which included a Council position statement that any leases granted on The Spit should be term leases and not perpetual leases. In this instance, Sunland's Special Lease No. 52285 is for a fixed term, it is not a perpetual lease.

However, it should be noted that matters of tenure involving State owned land on The Spit are ultimately matters for the State Government to resolve. It should also be noted that the *Land Act 1994* was recently amended. In summary, and in relation to your queries, the conversion of lease land to freehold land is allowable, but conversion to a perpetual lease is limited to sites that are used for tourism purposes and sites that are on an island (refer to section 100 of the *Land Act 1994*). In this regard, any conversion will be a matter for the State Government to determine should Sunland wish to make an application of this in the future.

With respect to the Sunland development application currently being assessed by Council, Special Lease No 52285 contains the necessary conditions to satisfy the 'owner's consent' requirements of the *Sustainable Planning Act 2009* and thus the Sunland application is a properly made application.

60830364

Page 1 of 2

Subject: Solar PV in QLD

From: Sch 4 CTPI (hit-reply@linkedin.com)

To: mangocube6@yahoo.co.uk;

Date: Tuesday, 1 December 2015, 3:59

Dear Hon. Bailey,

I am very happy to be able to contact you on this forum. I am Asia-Pacific SVP at SkyPower and think that Australia can become a powerhouse in solar PV. I am especially interested in investing in QLD due to its solar irradiation, future energy demand and current Gov't. I will send you a request to connect. Thank you for accepting. I would also like to meet you to discuss partnership, if possible, between us and QLD Gov't/ERGON, if possible of course? Maybe a P3 project. Thank you for your time. I am looking forward to your reply. Best,

Sch 4 CTPI

View Sch 4 CTPI LinkedIn profile

This email was intended for Mark Bailey (MP for State Seat of Yeerongpilly, Minister for Main Roads, Road Safety, Ports, Energy, Water Supply). Learn why we included this.

You are receiving InMail notification emails. [Unsubscribe](#)
If you need assistance or have questions, please contact [LinkedIn Customer Service](#).

© 2015, LinkedIn Corporation. 2029 Stierlin Ct. Mountain View, CA 94043, USA

Released under RIA Act - 2015

Subject: Re: Sunland - Spit land - DNRM Delegated Authority?

From: [redacted] Sch 4 CTPI

To: mangocube6@yahoo.co.uk;

Date: Wednesday, 2 December 2015, 7:18

Nice one Mark :)

A bit of balance on the GC will go along way

<http://www.goldcoastbulletin.com.au/tates-spray-over-waterways-axing-slamming-government-over-dumping-of-gary-baildon/story-fnj90t7b-1227630360809>

On 2 December 2015 at 00:23, Mark Bailey <mangocube6@yahoo.co.uk> wrote:
Just saw this now. Had a bill today so flat strap. Will look at it tomorrow. M

Sent from my iPhone

On 30 Nov 2015, at 7:51 PM, [redacted] Sch 4 CTPI > wrote:

Hi
I sent this to your work email today...
thanks

[redacted] Sch 4 CTPI

----- Forwarded message -----

From: [redacted] Sch 4 CTPI >
Date: 30 November 2015 at 13:11
Subject: Fwd: Sunland - Spit land - DNRM Delegated Authority?
To: mainroads@ministerial.qld.gov.au

Hon. Mark Bailey,

Please find attached a letter confirming the change of use agreement made by DNRP to Sunland for the Spit land on 4 July 2014. As you can see below, I have contacted Andrew Cripps to confirm this was in fact done by Delegated Authority. I can't imagine how this was proper process (to authorise without input from either the then minister or the GCCC) given the significance of this change for the Gold Coast.

How do I find out if due process was in fact undertaken or not?

kind regards

[redacted] Sch 4 CTPI

Sch 4 CTPI

m NR

----- Forwarded message -----

From: [redacted] Sch 4 CTPI
Date: 30 November 2015 at 12:56
Subject: Sunland - Spit land - DNRM Delegated Authority?
To: hinchinbrook@parliament.qld.gov.au

Dear Andrew,

I am doing some investigating into the approval process far for the Sunland Spit lease. John-Paul Langbroek provided me the attached document which confirms the DNRM approved the amendment of the lease to include the operation of residential accommodation and reclamation without any input for the Gold Coast City Council on 4 July 2014.

John-Paul thought you were not made aware of this decision at the time. Instead it was made by Delegated Authority by a public servant within DNRM. Could you please confirm if this is in fact the case? If so, would you have any record/ recollection of who made the Deleted Authority and why they were provided the authority to do this without seeking any comment from the Gold Coast City Council?

kind regards

Sch 4 CTPI

Sch 4 CTPI

m NR

<Sunland DA30112015.pdf>

Subject: FW: 20 Townsville Ventia workers sacked weeks from Christmas
From: Stuart Traill (stuart@etu.org.au)
To: Sch 4 CTPI mangocube6@yahoo.co.uk;
Cc: simmo@etu.org.au;
Date: Tuesday, 8 December 2015, 11:16

FYI,

We still have a significant amount of waste and bloated management/support staff and now they cut frontline contract resources with Zero consultation. They are hiding behind a reduced works programme due to the AER, why they hell do we have so many indirect/support staff.

I have our Burleigh Energex members about to have a sit in tomorrow morning until they get an answer why Energex is letting two Linesmen go in early January which will leave only 6 linesman from Southport to the NSW border. We have tried internal escalation processes and our members have no further options.

These grubs are cutting frontline workers on the back of the AER cuts instead of getting rid of the indirect costs.

Dave, I have sent you a text about this and need this fixed before this blows up, we won't allow storm response to be significantly reduced prior to Christmas.

Tomorrow if we have members on the grass I imagine these Knuckleheads will try and get 418 orders against our members instead of fixing the issues of under resourcing, if they do it will be on like Donkey Kong.

Give me a call please.

Stuey.

From: Dan Nancarrow
Sent: Tuesday, 8 December 2015 10:51 AM
Subject: 20 Townsville Ventia workers sacked weeks from Christmas

Hi all,

about:blank

1/4

Attached and below is the press release on the 20 workers sacked by Ventia just weeks from Christmas,

Wal Giordani NR is available for media comment,

Cheers,

Twenty Townsville Ventia workers sacked weeks from Christmas

ETU calling for company to offer voluntary redundancies

Ventia has given its employees the worst possible gift in the lead up to the Christmas holidays by heartlessly sacking 20 Townsville electricity workers.

The company have cowardly used the Australian Energy Regulator's decision as an excuse for the redundancies, despite Ergon Energy not publicly stating what the resourcing impacts of the decision would be.

The ETU has called on the company to consult with the Union and offer voluntary redundancies.

Townsville ETU Organiser Wal Giordani said the ETU believed the sackings were targeted at Union members.

"To do this leading into Christmas to workers, with families to think of, is just cold-hearted," he said.

"Ventia won't say what the criteria for the redundancies are and they've told us they won't offer voluntary redundancies.

"This move is nothing but payback from the company to members who voted in favour of taking industrial action during protracted EBA negotiations - negotiations where attempts were made to cut redundancy entitlements."

The ETU has also called on Ergon Energy reemploy the sacked workers in the 80-odd vacancies within the energy company throughout the state.

Mr Giordani said it was time Ergon started controlling reckless rogue contractors like Ventia.

“Management are taking the opportunity to cut staff numbers to increase profit to payback their new owners in the joint venture - CIMIC and Apollo Funds Management,” he said.

“Ventia are using the AER decision as a cover, despite not knowing what the impacts on Ergon will be.

“We’ve been calling on Ergon to rein in these rogue contractors for years, but these calls continue to fall on deaf ears.”

The ETU believes the sackings are just the tip of the iceberg and there could be more job losses to come in the company at Sunshine Coast, Rockhampton and Brisbane depots.

Compounding the heartlessness of the decision, two apprentices – both six to 12 months from completing their trade – were among those sacked.

“I am disgusted that they would do this to someone this late in their apprenticeship, especially on top of it being Christmas time,” he said.

Further information please contact: Wal Giordani **or Dan Nancarrow**

Dan Nancarrow

Media Officer

ETU Queensland and NT

Mob

Office 07 3010 0317

Email media@etu.org.au

Disclaimer

The information contained in the e-mail is intended only for the use of the person(s) to whom it is addressed and may be confidential or contain legally privileged information. If you are not the intended recipient you are notified that any perusal, use, distribution, copying or disclosure is strictly prohibited. If you have received this e-mail in error please immediately advise us by return e-mail and delete the e-mail document without making a copy.

The Electrical Trades Union Queensland has virus scanning devices on our system but in no way do we represent that this communication (including any files attached) is free from computer viruses or other faults or defects. We will not be held liable to you or to any other person for loss and damage (including direct, consequential or economic loss or damage) however caused and whether by negligence or otherwise which may result directly or indirectly from the receipt or use of this communication or attached files.

Attachments

- VentiaTownsville8122015.docx (1.10 MB)

Released under RTI Act - TMR



Media Release

8 December 2015
Attention: General reporters

Townsville Ventia workers sacked weeks from Christmas

ETU calling for company to offer voluntary redundancies

Ventia has given its employees the worst possible gift in the lead up to the Christmas holidays by heartlessly sacking 20 Townsville electricity workers.

The company have cowardly used the Australian Energy Regulator's decision as an excuse for the redundancies, despite Ergon Energy not publicly stating what the resourcing impacts of the decision would be.

The ETU has called on the company to consult with the Union and offer voluntary redundancies.

Townsville ETU Organiser Wal Giordani said the ETU believed the sackings were targeted at Union members.

"To do this leading into Christmas to workers, with families to think of, is just cold-hearted," he said.

"Ventia won't say what the criteria for the redundancies are and they've told us they won't offer voluntary redundancies.

"This move is nothing but payback from the company to members who voted in favour of taking industrial action during protracted EBA negotiations - negotiations where attempts were made to cut redundancy entitlements."

The ETU has also called on Ergon Energy reemploy the sacked workers in the 80-odd vacancies within the energy company throughout the state.

Mr Giordani said it was time Ergon started controlling reckless rogue contractors like Ventia.

"Management are taking the opportunity to cut staff numbers to increase profit to payback their new owners in the joint venture - CIMIC and Apollo Funds Management," he said.

"Ventia are using the AER decision as a cover, despite not knowing what the impacts on Ergon will be.

"We've been calling on Ergon to rein in these rogue contractors for years, but these calls continue to fall on deaf ears."

The ETU believes the sackings are just the tip of the iceberg and there could be more job losses to come in the company at Sunshine Coast, Rockhampton and Brisbane depots.

Compounding the heartlessness of the decision, two apprentices – both six to 12 months from completing their trade – were among those sacked.

"I am disgusted that they would do this to someone this late in their apprenticeship, especially on top of it being Christmas time," he said.

Further information please contact: Wal Giordani or Dan Nancarrow

Authorised by P.J Simpson, ETU Divisional Branch Secretary

Subject: Re: 20 Townsville Ventia workers sacked weeks from Christmas
From: Peter Simpson (ETU) (simmo@etu.org.au)
To: stuart@etu.org.au;
Cc: Sch 4 CTPI; mangocube6@yahoo.co.uk;
Date: Tuesday, 8 December 2015, 11:19

Comrades, we need to pull all this AER madness up until we've all had a chance to plan the merger stuff in the New Year!

Letting skilled tradespersons go, including Apprentices, two weeks before Xmas is absolute madness, especially when there will be redundancies coming next year that won't be from your front line is people.

Simmo

Sent from my iPhone

On 8 Dec 2015, at 11:15 AM, Stuart Traill <stuart@etu.org.au> wrote:

FYI,

We still have a significant amount of waste and bloated management/support staff and now they cut frontline contract resources with Zero consultation. They are hiding behind a reduced works programme due to the AER, why they hell do we have so many indirect/support staff.

I have our Burleigh Energex members about to have a sit in tomorrow morning until they get an answer why Energex is letting two Linesmen go in early January which will leave only 6 linesman from Southport to the NSW border. We have tried internal escalation processes and our members have no further options.

These grubs are cutting frontline workers on the back of the AER cuts instead of getting rid of the indirect costs.

Dave, I have sent you a text about this and need this fixed before this blows up, we won't allow storm response to be significantly reduced prior to Christmas.

Tomorrow if we have members on the grass I imagine these Knuckleheads will try and get 418 orders against our members instead of fixing the issues of under resourcing, if they do it will be on like Donkey Kong.

Give me a call please.

Stuey.

From: Dan Nancarrow
Sent: Tuesday, 8 December 2015 10:51 AM
Subject: 20 Townsville Ventia workers sacked weeks from Christmas

Hi all,

Attached and below is the press release on the 20 workers sacked by Ventia just weeks from Christmas,

Wal Giordani NR is available for media comment,

Cheers,

Twenty Townsville Ventia workers sacked weeks from Christmas

ETU calling for company to offer voluntary redundancies

Ventia has given its employees the worst possible gift in the lead up to the Christmas holidays by heartlessly sacking 20 Townsville electricity workers.

The company have cowardly used the Australian Energy Regulator’s decision as an excuse for the redundancies, despite Ergon Energy not publicly stating what the resourcing impacts of the decision would be.

The ETU has called on the company to consult with the Union and offer voluntary redundancies.

Townsville ETU Organiser Wal Giordani said the ETU believed the sackings were targeted at Union members.

“To do this leading into Christmas to workers, with families to think of, is just cold-hearted,” he said.

“Ventia won’t say what the criteria for the redundancies are and they’ve told us they won’t offer voluntary redundancies.

“This move is nothing but payback from the company to members who voted in favour of taking industrial action during protracted EBA negotiations - negotiations where attempts were made to cut redundancy entitlements.”

The ETU has also called on Ergon Energy reemploy the sacked workers in the 80-odd vacancies within the energy company throughout the state.

Mr Giordani said it was time Ergon started controlling reckless rogue contractors like Ventia.

“Management are taking the opportunity to cut staff numbers to increase profit to payback their new owners in the joint venture - CIMIC and Apollo Funds Management,” he said.

“Ventia are using the AER decision as a cover, despite not knowing what the impacts on Ergon will be.

“We’ve been calling on Ergon to rein in these rogue contractors for years, but these calls continue to fall on deaf ears.”

The ETU believes the sackings are just the tip of the iceberg and there could be more job losses to come in the company at Sunshine Coast, Rockhampton and Brisbane depots.

Compounding the heartlessness of the decision, two apprentices – both six to 12 months from completing their trade – were among those sacked.

“I am disgusted that they would do this to someone this late in their apprenticeship, especially on top of it being Christmas time,” he said.

Further information please contact: Wal Giordani **or Dan Nancarrow**

Dan Nancarrow

Media Officer

ETU Queensland and NT

Mob

Office 07 3010 0317

Email media@etu.org.au

Disclaimer

The information contained in the e-mail is intended only for the use of the person(s) to whom it is addressed and may be confidential or contain legally privileged information. If you are not the intended recipient you are notified that any perusal, use, distribution, copying or disclosure is strictly prohibited. If you have received this e-mail in error please immediately advise us by return e-mail and delete the e-mail document without making a copy.

The Electrical Trades Union Queensland has virus scanning devices on our system but in no way do we represent that this communication (including any files attached) is free from computer viruses or other faults or defects. We will not be held liable to you or to any other person for loss and damage (including direct, consequential or economic loss or damage) however caused and whether by negligence or otherwise which may result directly or indirectly from the receipt or use of this communication or attached files.

<VentiaTownsville8122015.docx>

Released under RTI Act - TMR

Subject: Fwd: Select Solutions
From: Peter Simpson (ETU) (simmo@etu.org.au)
To:
Date: Wednesday, 16 December 2015, 16:14

Sent from my iPhone

Begin forwarded message:

From: "Peter Simpson (ETU)" <simmo@etu.org.au>
Date: 16 December 2015 at 1:36:10 PM AEST
To: Stuart Traill <stuart@etu.org.au>, "McLEOD Ian (NQ)" <ian.mcleod@ergon.com.au>
Cc: "MONTGOMERY Brad (NQ) (Brad.Montgomery@ergon.com.au)" <Brad.Montgomery@ergon.com.au>, Brenton Muller <brenton@etu.org.au>
Subject: Re: Select Solutions

Ian,

See below, we'd expect nothing less than this contractor to be immediately stood down

Please advise asap if that isn't your reaction so we can react accordingly

Simmo

Simmo

Sent from my iPhone

On 16 Dec 2015, at 1:28 PM, Stuart Traill <stuart@etu.org.au> wrote:

Brad,

We have serious issues with Select.

Three final read and disconnect jobs for the Calliope Shopping Centre were recently issued to Select Solutions. This required the removal of tails from the meter ie electrical work done by licensed electrical worker.

It was allocated to the tough pad EFA 05059 and could not be done by that employee, it was reallocated to a meter reader(non licensed) who allegedly advised he couldn't complete the job due to not having the required fields on his toughpad. The job was then reallocated to [Sch 4 CTPI] and the details of the completion of that job were inputted by [Sch 4 CTPI] whilst we believe he was in Rockhampton. It is our view that this information was relayed by the non licensed meter reader to [Sch 4 CTPI]

Sch 4 CTF Following the completion of the work by a non licensed person, all of this should be able to be tracked by Ergon and Select and compared with GPS devices.

Can you please investigate and advise of your findings?

If they have done this I request an immediate suspension of their contract and a full review of all works allocated to ensure that only licensed workers have done electrical work.

Please confirm.

Regards,

Stuart Traill

Supply Industry Coordinator

Electrical Trades Union

Queensland

M. NR

F. (07) 40513502

stuart@etu.org.au

www.etu.org.au

[<image001.png>](#)

Join Online

www.etuyes.com

Or call

1800ETUYES

[<image002.jpg>](#)

[<image003.jpg>](#)

[<image004.png>](#)

Attachments

- image002.jpg (1.48 KB)
- image003.jpg (1.08 KB)
- image001.png (5.07 KB)
- image004.png (154.71 KB)

Released under RTI Act - TMR

Subject: Re: Fwd: Select Solutions
From: David Shankey [Sch 4 CTPI]
To: mangocube6@yahoo.co.uk;
Date: Wednesday, 16 December 2015, 19:51

I am bcc ed in too.

Its been referred to the office of electrical safety, fuggedaboutit.

Mark Bailey wrote:

FYI...

Sent from my iPhone

Begin forwarded message:

From: "Peter Simpson (ETU)" <simmo@etu.org.au>
Date: 16 December 2015 at 7:13:51 AM GMT+1
Subject: Fwd: Select Solutions

Sent from my iPhone

Begin forwarded message:

From: "Peter Simpson (ETU)" <simmo@etu.org.au>
Date: 16 December 2015 at 1:36:10 PM AEST
To: Stuart Traill <stuart@etu.org.au>, "McLEOD Ian (NQ)" <ian.mcleod@ergon.com.au>
Cc: "MONTGOMERY Brad (NQ) (Brad.Montgomery@ergon.com.au)" <Brad.Montgomery@ergon.com.au>, Brenton Muller <brenton@etu.org.au>
Subject: Re: Select Solutions

Ian,

See below, we'd expect nothing less than this contractor to be immediately stood down

Please advise asap if that isn't your reaction so we can react accordingly

Simmo

Simmo

Sent from my iPhone

On 16 Dec 2015, at 1:28 PM, Stuart Traill <stuart@etu.org.au> wrote:

Brad,

We have serious issues with Select.

Three final read and disconnect jobs for the Calliope Shopping Centre were recently issued to Select Solutions. This required the removal of tails from the meter ie electrical work done by licensed electrical worker.

It was allocated to the tough pad EFA 05059 and could not be done by that employee, it was reallocated to a meter reader(non licensed) who allegedly advised he couldn't complete the job due to not having the required fields on his toughpad. The job was then reallocated to Shane Hall and the details of the completion of that job were inputted by Shane Hall whilst we believe he was in Rockhampton. It is our view that this information was relayed by the non licensed meter reader to Shane Hall following the completion of the work by a non licensed person, all of this should be able to be tracked by Ergon and Select and compared with GPS devices.

Can you please investigate and advise of your findings?

If they have done this I request an immediate suspension of their contract and a full review of all works allocated to ensure that only licensed workers have done electrical work.

Please confirm.

Regards,

Stuart Traill

Supply Industry Coordinator

Electrical Trades Union

Queensland

M NR

F. (07) 40513502

stuart@ctu.org.au

www.ctu.org.au

[<image001.png>](#)

Join Online

www.etuyes.com

Or call

1800ETUYES

[<image002.jpg>](#)

[<image003.jpg>](#)

[<image004.png>](#)

www.not4sale.org.au



twitter



STOP THE CHINA FREE TRADE AGREEMENT
 Protect our jobs Protect our sovereignty Protect our standards



Attachments

- image.jpg (2.44 KB)
- image.jpg (1.73 KB)
- image.png (5.19 KB)
- image.png (193.38 KB)

Subject: Draft Presser

From: Peter Simpson (ETU) (simmo@etu.org.au)

To:

Cc: Sch 4 CTPI mangocube6@yahoo.co.uk; Sch4 CTPI Sch 4 CTPI
peter.billing@ergon.com.au;

Date: Thursday, 17 December 2015, 10:23

Attachments

- SelectSolutions Press Release 17122015.docx (1.10 MB)

Released under RTI Act - TMR

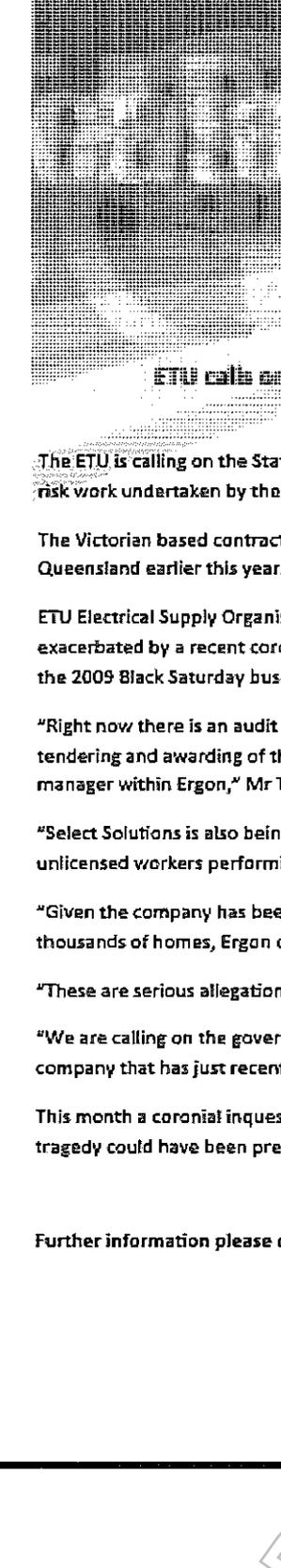

ETU calls on government to force out dangerous 'Black Saturday' contractor
Union fears ongoing safety issues could lead to further fatal incidents

The ETU is calling on the State Government to step in and force Ergon to sack rogue contractor Select Solutions before high risk work undertaken by the company's unlicensed workers results in a fatal incident in Queensland.

The Victorian based contractor has been causing ongoing issues in the electrical industry since they began operating in Queensland earlier this year.

ETU Electrical Supply Organiser Stuart Traill said there had been ongoing safety issues with the contractor in Queensland, exacerbated by a recent coronial inquest in Victoria finding Select Solutions' parent company AusNet Services responsible for the 2009 Black Saturday bushfires.

"Right now there is an audit being undertaken into the contractor's wages and conditions and there is also an audit into the tendering and awarding of the contract to the company because the state manager of Select Solutions used to be serious manager within Ergon," Mr Traill said.

"Select Solutions is also being investigated over allegations of a number of electrical safety breaches, including having unlicensed workers performing electrical work.

"Given the company has been out in Queensland working on domestic installations since the middle of the year, taking in thousands of homes, Ergon cannot guarantee us that all of those jobs have been done by qualified electrical tradespeople.

"These are serious allegations with serious safety implications.

"We are calling on the government to step in and tell Ergon to sack this rogue contractor who are owned by the same company that has just recently been found to be directly responsible for causing the fatal Black Saturday bushfires."

This month a coronial inquest into the 2009 Victorian bushfires that destroyed Marysville and killed 40 people found the tragedy could have been prevented if AusNet Services had followed basic safety standards.

Further information please contact: Stuart Traill NR or Dan Nancarrow NR

Subject: Re: ^_One^_ for ^_You^_ ^_DG^_!

From: Neil.Z.Scales@tmr.qld.gov.au
To: mangocube6@yahoo.co.uk
Date: Tuesday, 22 December 2015, 8:06:28 am AEST

Thank you!

I got to get one of these.....

Kind regards,

Neil Scales

Director-General (Transport and Main Roads) | Executive Directorate
Office Of The Director-General | Department of Transport and Main Roads

Floor 13 | Capital Hill | 85 George Street | Brisbane Qld 4000
GPO Box 1549 | Brisbane Qld 4001
P: (07) 30667316 | F: (07) 30667122
E: neil.z.scales@tmr.qld.gov.au
W: www.tmr.qld.gov.au

On 22 Dec 2015, at 5:49 AM, Mark Bailey <mangocube6@yahoo.co.uk> wrote:

<IMG_9963.JPG>

Sent from my iPhone

WARNING: This email (including any attachments) may contain legally privileged, confidential or private information and may be protected by copyright. You may only use it if you are the person(s) it was intended to be sent to and if you use it in an authorised way. No one is allowed to use, review, alter, transmit, disclose, distribute, print or copy this email without appropriate authority.

If this email was not intended for you and was sent to you by mistake, please telephone or email me immediately, destroy any hardcopies of this email and delete it and any copies of it from your computer system. Any right which the sender may have under copyright law, and any legal privilege and confidentiality attached to this email is not waived or destroyed by that mistake.

It is your responsibility to ensure that this email does not contain and is not affected by computer viruses, defects or interference by third parties or replication problems (including incompatibility with your computer system).

Opinions contained in this email do not necessarily reflect the opinions of the Department of Transport and Main Roads, or endorsed organisations utilising the same infrastructure.

Subject: Re: Select

From: Peter Simpson (ETU) (simmo@etu.org.au)

To: stuart@etu.org.au;

Cc: Brad.Montgomery@ergon.com.au; jeffrey.green@ergon.com.au; Chris.McGaw@Ergon.com.au; Peter.BILLING@ergon.com.au;

Date: Tuesday, 22 December 2015, 8:28

That's, CCC stuff Stu, can you please refer that on

Simmo

Peter Simpson
State Secretary
Electrical Trades Union
Queensland
M. NR
F. (07) 3844 9851
simmo@etu.org.au
www.etu.org.au

Join Online
www.etuyes.com
Or call
1800ETUYES

Disclaimer

The information contained in the e-mail is intended only for the use of the person(s) to whom it is addressed and may be confidential or contain legally privileged information. If you are not the intended recipient you are notified that any perusal, use, distribution, copying or disclosure is strictly prohibited. If you have received this e-mail in error please immediately advise us by return e-mail and delete the e-mail document without making a copy.

- > On 22 Dec 2015, at 8:23 AM, Stuart Traill <stuart@etu.org.au> wrote:
- >
- > Brad,
- > Can you also include the below issue into the Select investigation?
- > I have been advised that Select staff and subbies have been putting their own personal mobile numbers on the form B that identifies defects in the customers installation.
- > These defects must be repaired prior to reconnection.
- > What has allegedly been occurring is that the customers are then left with the easiest option of getting them to repair the defects.
- > This is a conflict of interest and not in accordance with Ergons policies.
- > It is starting to look more like Ergon is making excuses for this contractor to drive down the rates for the decent operators to unsustainable levels.
- > Stuey.
- > Sent from my iPhone

Subject: ^_Mike^_^_sent^_^_you^_^_a^_^_new^_^_message^_^_

From: messages-noreply@linkedin.com

To: mangocube6@yahoo.co.uk

Date: Sunday, 3 January 2016 01:42:58 PM AEST



Mark Bailey 



Sch 4 CTPI

Mark - saw you in tv last night. I had no idea. Congrats on new role. Very impressive.

Hoping to present a proposal to stephen Myles on food and green waste composting from households - offset 50%... see more

Reply

[Change frequency](#) | [Unsubscribe](#) | [Help](#)

You are receiving Messages from connections digest emails.

This email was intended for Mark Bailey (MP for State Seat of Yeerongpilly, Minister for Main Roads, Road Safety, Ports, Energy, Water Supply). Learn why we included this.



© 2016 LinkedIn Ireland, Wilton Plaza, Wilton Place, Dublin 2. LinkedIn is a registered business name of LinkedIn Ireland. LinkedIn and the LinkedIn logo are registered trademarks of LinkedIn.

Subject: Re: Wired Article
From: Peter Simpson (ETU) (simmo@etu.org.au)
To: mangocube6@yahoo.co.uk;
Date: Monday, 11 January 2016, 18:25

Scary but exciting,

Sch 4 CTPI

Cheers Comrade

Regards,

Peter Simpson
State Secretary
Electrical Trades Union
Queensland
M. NR
F. (07) 3844 9851
simmo@etu.org.au
www.etu.org.au

Join Online
www.etuyes.com
Or call
1800ETUYES

Disclaimer

The information contained in the e-mail is intended only for the use of the person(s) to whom it is addressed and may be confidential or contain legally privileged information. If you are not the intended recipient you are notified that any perusal, use, distribution, copying or disclosure is strictly prohibited. If you have received this e-mail in error please immediately advise us by return e-mail and delete the e-mail document without making a copy.

On 11 Jan 2016, at 4:05 PM, Mark Bailey <mangocube6@yahoo.co.uk> wrote:

<http://www.wired.com/2016/01/the-metastructure-transportation>

Subject: Re: Wired Article
From: Peter Simpson (ETU) (simmo@etu.org.au)
To: mangocube6@yahoo.co.uk;
Date: Monday, 11 January 2016, 16:25

Ta mate

Regards,

Peter Simpson
State Secretary
Electrical Trades Union
Queensland
M. NR
F. (07) 3844 9851
simmo@etu.org.au
www.etu.org.au

Join Online
www.etuyes.com
Or call
1800ETUYES

Disclaimer

The information contained in the e-mail is intended only for the use of the person(s) to whom it is addressed and may be confidential or contain legally privileged information. If you are not the intended recipient you are notified that any perusal, use, distribution, copying or disclosure is strictly prohibited. If you have received this e-mail in error please immediately advise us by return e-mail and delete the e-mail document without making a copy.

On 11 Jan 2016, at 4:05 PM, Mark Bailey <mangocube6@yahoo.co.uk> wrote:

<http://www.wired.com/2016/01/the-metastructure-transportation>

Subject: FW: Network Merger Communications
From: Peter Simpson (ETU) (simmo@etu.org.au)
To: mangocube6@yahoo.co.uk;
Date: Thursday, 14 January 2016, 9:49

From: Peter Simpson (ETU)
Sent: Thursday, 14 January 2016 9:46 AM
To: 'John Frazer' <JFrazer@qtc.com.au>; Neil Henderson <Neil.Henderson@theservicesunion.com.au>; rohan.webb@amwu.asn.au; AKerslake@professionalsaustralia.org.au
Cc: Stuart Traill <stuart@etu.org.au>
Subject: RE: Network Merger Communications

John,

I've just read through this and we want to highlight our disgust that this has been tabled before the framework etc we had been working on before Christmas and indeed over the break, has been finalised.

My first reaction is to tell QTC to stick all consultation where the sun doesn't shine and ramp up an industrial campaign I'll be honest. I naively thought that QTC may have had a more consultative view of the world in the wake of Newman's demise, I was obviously wrong.

I'll talk to the others and let Govt know our collective position

Simmo

From: John Frazer [mailto:JFrazer@qtc.com.au]
Sent: Thursday, 14 January 2016 8:48 AM
To: Peter Simpson (ETU) <simmo@etu.org.au>; Neil Henderson <Neil.Henderson@theservicesunion.com.au>; rohan.webb@amwu.asn.au; AKerslake@professionalsaustralia.org.au
Cc: kscott@professionalsaustralia.or.au
Subject: Network Merger Communications

Peter, Neil, Rohan and Adam

As per my email last night and telephone conversations, please find attached communications to all staff of Ergon, Energex and SPARQ.

As you can see this comms is only an update and relates mostly to the establishment of workstreams and the transfer of various personnel from the businesses to the project team. You will also note that there is a reference to the establishment of an Industrial Relation Group

The businesses will be releasing these communications to all staff at 10am so I would appreciate if you could embargo any release from your unions until this time.

Please call me if you have any questions.

Regards

John

John Frazer

Executive General Manager | Risk Analysis Division

Queensland Treasury Corporation



GPO Box 1096 Brisbane Queensland Australia 4001 | Level 6 123 Albert St Brisbane Queensland 4000

T +61 (0)7 3842 4856 | M + NR | jfrazer@qtc.com.au | www.qtc.com.au

COMMERCIAL-IN-CONFIDENCE - FOR THE PURPOSE OF PREPARATION OF A REPORT TO CABINET

IMPORTANT: This email transmission including any attachments to it is confidential. It may contain information that is subject to privilege or privacy obligations, or being utilised for preparation of a report to the Queensland Government Cabinet or which is protected by copyright or other intellectual property rights.

If you are not the intended recipient of this email transmission, any use, interference with, disclosure or copying of this email transmission or action taken in reliance on this email transmission is unauthorised, prohibited and may be unlawful. Please notify us if you have received this email transmission in error and delete the email.

If you are the intended recipient, you must ensure that this email transmission and the information it contains is treated so as to maintain confidentiality and privilege, and ensure that privacy obligations are observed. No copy, summary or reference to any advice or information contained in this email transmission is to be included in another document or provided outside of Queensland Treasury Corporation without the prior consent of the Project Director, Electricity Mergers Project Team.

This email including attachments is intended only for the addressee and may be confidential and privileged. If you are not the addressee, you must not copy or use this email for any purpose, nor disclose its contents to anyone, please delete it and notify the sender by return email. | Any opinion or advice provided in this message is subject to any assumptions noted within it and the assumption that the current economic, political and/or commercial environment does not materially alter. QTC does not warrant or guarantee any outcome or forecast in this message. Any opinion or advice in this message is provided by QTC in good faith on the basis of information supplied to QTC. QTC has not independently verified the information supplied to it, and accordingly does not represent that the information provided to QTC is accurate or complete and it should not be relied upon as such. | To the extent permitted by law, neither QTC nor any of its employees, contractors, servants or agents accept any responsibility and liability whatsoever for any expense, damage, claim, cause of action, loss or costs, incurred by any person in connection with that person or any other person placing any reliance on, or acting or refraining to act on the basis of, the contents of this email. | QTC respects your privacy, and our privacy plan is available on our website.

Attachments

- image001.jpg (3.56 KB)

Released under RTI Act - TMR

Subject: ^_Fwd^_: ^_Traffic^_ ^_Signal^_ ^_intersections^_

From: Mark.Bailey@ministerial.qld.gov.au

To: mangocube6@yahoo.co.uk

Date: Friday, 15 January 2016 09:20:20 AM AEST

Sent from my iPhone

Begin forwarded message:

From: Neil Scales <Neil.Z.Scales@tmr.qld.gov.au>
Date: 15 January 2016 at 9:06:21 AM AEST
To: Minister Mark Bailey <mark.bailey@ministerial.qld.gov.au>
Subject: Fwd: Traffic Signal intersections

Good Morning Minister,

As discussed.

Happy to progress CBD issues with Colin at BCC.

Kind regards,

Neil Scales

Director-General (Transport and Main Roads) | Executive Directorate
Office Of The Director-General | Department of Transport and Main Roads

Floor 13 | Capital Hill | 85 George Street | Brisbane Qld 4000

GPO Box 1549 | Brisbane Qld 4001

P: (07) 30667316 | F: (07) 30667122

E: neil.z.scales@tmr.qld.gov.au

W: www.tmr.qld.gov.au

Begin forwarded message:

From: Dennis J Walsh <dennis.j.walsh@tmr.qld.gov.au>
Date: 15 January 2016 at 8:53:45 AM AEST
To: Neil Scales <Neil.Z.Scales@tmr.qld.gov.au>
Subject: FW: Traffic Signal intersections

Neil

Just following up on your query regarding intersections:

BCC Signals on George Street

- Yet to be confirmed by BCC traffic engineers but we suspect that they run fixed time in the CBD grided network with automatic call up for pedestrian movements at some intersections (which would explain the long side street delays)
- Delays could be reduced by running “plan 99” message from SCATS or potentially SCATS VA protocol message from SCATS to the relevant controller/s. This would not require any changes to hardware in the field.
- Such operation may be appropriate for out of normal business hours (later at night and early morning) of operation depending on BCC policy regards catering for pedestrians at these times.

Converting Intersections to “smart intersections” – there are a number of scenarios here as follows

Scenario 1 – intersection without traffic signals

- The cost to signalise can vary from around \$0.5M (pedestrian crossing only) up to \$2M (for complex intersections for example, some of the ones on the gold coast light rail corridor or large complex intersection with multi lane entries)

Scenario 2 – intersection is currently running isolated and not on STREAMS

- Requires new field processor, communications link, installation by RoadTek and configuration on STREAMS
- Cost around \$5-6K per intersection in urban built up area (dependent upon availability of Telstra and Energex/Ergon services – where these are not readily available the cost can escalate)

Scenario 3 – Traffic Signal Optimisation for intersections that are on STREAMS or SCATS

- This requires detailed traffic engineering analysis, traffic signal personality programming, STREAMS configuration data and ground truthing operations
- For a typical route or group of say 10-15 intersections this exercise can cost up to \$50K depending on complexity
- Previous large scale optimisation of 10 joint routes between BCC and TMR cost well over \$0.5M (over 150 intersections from memory)

Scenario 4 – Conversion of SCATS intersections to operate under STREAMS

- Similar in cost to scenario 2 plus some of the effort required in scenario 3 to optimise operations

Regards

Dennis Walsh

M: NR
E: dennis.j.walsh@tmr.qld.gov.au
W: www.tmr.qld.gov.au

 cid:image001.png@01CF5990.510FDAF0

WARNING: This email (including any attachments) may contain legally privileged, confidential or private information and may be protected by copyright. You may only use it if you are the person(s) it was intended to be sent to and if you use it in an authorised way. No one is allowed to use, review, alter, transmit, disclose, distribute, print or copy this email without appropriate authority.

If this email was not intended for you and was sent to you by mistake, please telephone or email me immediately, destroy any hardcopies of this email and delete it and any copies of it from your computer system. Any right which the sender may have under copyright law, and any legal privilege and confidentiality attached to this email is not waived or destroyed by that mistake.

It is your responsibility to ensure that this email does not contain and is not affected by computer viruses, defects or interference by third parties or replication problems (including incompatibility with your computer system).

Opinions contained in this email do not necessarily reflect the opinions of the Department of Transport and Main Roads, or endorsed organisations utilising the same infrastructure.



Released under RTI Act - TMR

Subject: ^_Tesla^_^_P^_

From: Mark.Bailey@ministerial.qld.gov.au

To: mangocube6@yahoo.co.uk

Date: Tuesday, 19 January 2016, 12:03:38 am AEST

If not an intended recipient of this email, you must not copy, distribute or take any action(s) that relies on it; any form of disclosure, modification, distribution and /or publication of this email is also prohibited.

Unless stated otherwise, this email represents only the views of the sender and not the views of the Queensland Government.

Please consider the environment before printing this email.



IMG_1013.JPG
92kB



ATT00001.txt
25B

Released under RTI Act - TMP

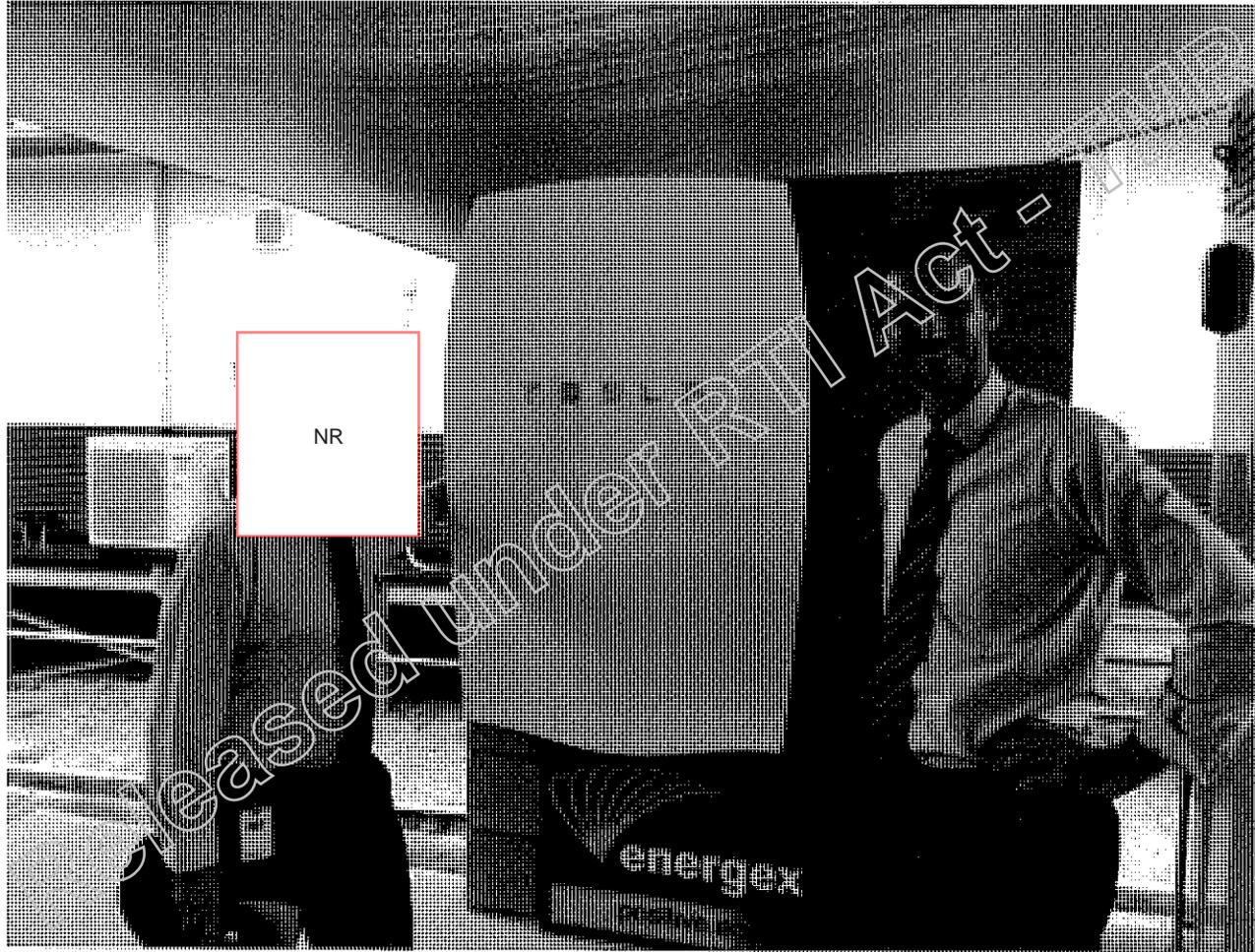

Subject: ^_Facebook^_ ^_alert^_: Your advert has been approved

From: advertise-noreply@support.facebook.com

To: mangocube6@yahoo.co.uk

Date: Tuesday, 19 January 2016, 9:55:00 am AEST

facebook

Hello Mark,

Your advert is approved. Thank you for advertising with Facebook.

Advert Name:	Post: /MarkBailey4Y/posts/1668885760047781 to your advert's audience
Advert Set Name:	Post: "The first Tesla Powerwall has arrived and its at..."
Campaign name:	Post: "The first Tesla Powerwall has arrived and its at..."
Account ID:	22596962
Advert Creator Name:	Mark Bailey

It may take some time for your advert to start running. Go to Adverts Manager to view and manage all of your adverts.

Thanks,

The Facebook Adverts Team

This is an automated message. Please don't reply. If you have questions about adverts, you can get help. You can also manage your email notification settings for this advertising account. Facebook, Inc., Department 415 P.O. Box 10005, Palo Alto, CA 94303. USA [627842428:22596962]

Released Under RIAA/FOIA/EMR

Subject: ^_Fwd^_ : ^_Inglewood^_ ^_Public^_ ^_Meeting^_ ^_Wednesday^_ ^_19^_ ^_November^_

From: mangocube6@yahoo.co.uk

To: d.sweeney@acfonline.org.au

Date: Monday, 16 November 2015 10:35:35 AM AEST

FYI...

>

Date: 16 November 2015 at AM AEST

To:

Subject: Fwd: Inglewood Public Meeting Wednesday 19 November

Subject: FW: Inglewood Public Meeting Wednesday 19 November

From: Councillor Graeme Scheu [mailto:Mayor@grc.qld.gov.au]

Sent: Sunday, 15 November 2015

To:

Subject: FW: Inglewood Public Meeting Wednesday 19 November

Hi

I sent this to councillors and officers and Lawrence and Bruce Scott.

I don't expect any value in you coming early for the site meeting but if you want to, that is fine.

Cheers

Graeme Scheu

Mayor

Goondiwindi Regional Council

LMB 7, Inglewood, Queensland, 4387

P 07 4671 7400 M NR F 07 4671 7433

E Mayor@grc.qld.gov.au

www.grc.qld.gov.au



The information transmitted is for the use of the intended recipient only and may contain confidential and/or legally privileged material. If you have received this email in error please notify the Goondiwindi Regional Council, telephone 07 4671 7400 and delete all copies of this transmission together with any attachments. Opinions contained in this e-mail do not necessarily reflect the opinions of Goondiwindi Regional Council.

From: Councillor Graeme Scheu
Sent: Sunday, 15 November 2015 3:27 PM
To: Councillors
Cc: Directors; David Hayward; Kim Parker
Subject: Inglewood Public Meeting Wednesday 19 November

Hi All,

You will have seen the Press release by now and what has been arranged to spread the word about the proposal.

I have made it very clear to everyone that this council has no set agenda with this issue at this stage and we will wait to see what information can be provided before any decision is made. I have cooled down a bit now after the shock of it all on Friday.

So the drill is this.

Wednesday -

9am - The Federal officers will meet with interested councillors, officers, Lawrence, Bruce Scott (if available) and Jeff Hannaford as Chamber of Commerce president at 9am in Inglewood. We will travel by car to the site and do a site inspection before returning to Boardroom for any other briefing.

Noon - Public Meeting. I will prepare an agenda for this but basically it will be a welcome by myself and a set the scene meeting. We don't want this turning into a farcical mess but more a mature meeting gaining information in order to progress the issue or not. It may well take more than this one meeting and I suggest this will be the case.

Lawrence will hopefully address the meeting so to Brice if available and then we will hand over to the group of three experts.

Jackie Trad has contacted me as well and she will be overseas from Tuesday but will have someone from her office in attendance who may also join the pre meeting tour as well but I imagine just the meeting.

I have notified Tim Hoffman (Sgt of Police) of proceedings as I expect a plethora of media and the possibilities of some rent a crowd agitators.

There will be question and answers and I expect to be out of there by 4pm.

Thursday –

-

There will be no need for council or others on this day as it is earmarked for 30 min session for the public with experts. Interested parties book with Kim Parker. The 9am session is already booked.

From there, we will schedule further meetings as it is necessary and if required. They have scheduled in another two or possibly three visits.

Councillors and Officers, please advise Kim if you are attending the meeting so transport can be arranged. I suggest this is one of the most important sessions we as councillors will take part in.

History:

The landholder contacted me Saturday as he is also getting bombarded with calls. He too was amazed I knew nothing about it.

The Department advertised widely in Country Life and others Australia wide two years ago, for any interested individual to submit an application if they thought they had a suitable block. There were certain requirements and the department required 110 - I think hectares – maybe acres?

28 nominations were received and all were inspected and desktop assessed and reduced to 8 in the short list. From that 2 pulled out for reasons unknown and so the 6 sites are what is now the short list.

I understand that only two will be selected.

When I spoke to the landholder (who will be attending the meeting and may even be speaking), he freely spoke of his intentions. He has spoken to all of his immediate neighbours before commencing the process and none had any difficulty with the issue. Sch 4 CTPI and after going into it fully

and visiting the Lucas Heights Facility, he believes the community have a duty of care to store this low category medical waste especially if we are all wanting to take the benefits of medical progression however he will have more to say about that later.

One point that has also been released is the fact that the Local Government will receive at least \$10m in Infrastructure funding aside from the development and the landholder will be paid 4 times the valuation of his land. This has created all types of accusations around a money grab however I want to point out that the block from where the department has selected the 110 hcts is actually 1200 hctrs so part of the proposal is a sub division of the required land down to 110 hctrs, which obviously is below the minimum lot size. So he obviously is not trying to sell the whole block at premium rates.

I have also made it clear that this council will not simply be supporting the proposal for a cash rebate. While there may be unlimited upgrades required in Inglewood (one that quickly comes to mind), there is a lot more at stake here and obviously a very sensitive and serious issue that requires full attention either way.

Hope to see you Wednesday.

Graeme Scheu

Mayor

Goondiwindi Regional Council

LMB 7, Inglewood, Queensland, 4387

P 07 4671 7400 M NR F 07 4671 7433

E Mayor@grc.qld.gov.au

www.grc.qld.gov.au

**Goondiwindi
REGIONAL
COUNCIL**



The information transmitted is for the use of the intended recipient only and may contain confidential and/or legally privileged material. If you have received this email in error please notify the Goondiwindi Regional Council, telephone 07 4671 7400 and delete all copies of this transmission together with any attachments. Opinions contained in this e-mail do not necessarily reflect the opinions of Goondiwindi Regional Council.



Public Consultation Inglewood Nuclear Waste.doc
210.5kB

13 November 2015

PUBLIC CONSULTATION BEGINS AT INGLEWOOD FOLLOWING FEDERAL GOVERNMENT ANNOUNCEMENT

Goondiwindi Regional Council has today been inundated with queries following the announcement by the Federal Government that a property in the Omanama/Inglewood area has been one of the six sites shortlisted for a permanent National Radioactive Waste Management Facility. Earlier this year landholders in all states and territories were invited to voluntarily nominate land for this facility.

Goondiwindi Mayor, Councillor Graeme Scheu said today that he was extremely disappointed with the process and communication that has surrounded this announcement. "I was woken this morning at 5.30am by media asking my thoughts on the proposal". "It was embarrassing to reply that you will have to wait until I get the papers to let you know".

I don't believe this was the best process as the last thing I want are residents making assumptions without the facts before them. I am certainly in no position to indicate Councils support or otherwise until all the facts are on the table. Conversely, I would hate for the community of Inglewood to miss an opportunity should the site proposal stack up. We can't jump to conclusions.

Subsequently I have made a number of calls to Minister Frydenberg's office and have arranged representatives and experts from the Minister's office to attend a Public Consultation meeting in Inglewood next **Wednesday, November 18** at noon at the Inglewood Civic Centre.

Attending that meeting will be two officials from the department as well as a representative from Australian Nuclear Science and Technology Organisation.

Furthermore, any residents wishing to meet individually with these people can do so on **Thursday, 19th November** from 9am. Council encourages interested parties to reserve a time for appointments. Appointments can be made by contacting Goondiwindi Regional Council on 07 46717400 or email kparker@grc.qld.gov.au.

It is also proposed that a second round of consultations is held in the second week of December, and then a third in late January or early February 2016 if required.

The Minister for Resources, Energy and Northern Australia invites persons with a right or interest in the nominated land, along with members from the local communities, and other interested parties to provide comment on the proposed approvals prior to any decision. Comments received will assist the Minister's consideration of a shortlist of two to three sites for approval and subsequent detailed assessment.

More information on the consultation period and site nomination process can be found at www.radioactivewaste.gov.au

ENDS-

Word Count: 405

For further information please contact:
Councillor Graeme Scheu

Mayor Goondiwindi Regional Council

Mobile:

Email: GScheu@grc.qld.gov.au

Subject: Autonomous cars likely to increase congestion : Renew Economy

From: Sch 4 CTPI

To: mangocube6@yahoo.co.uk;

Date: Wednesday, 20 January 2016, 6:01

Hi Mark, nice to chat last night. More later on Energex and Alan Pears.. this caught my eye from our discussion of Autonomous vehicles...

<http://reneweconomy.com.au/2016/autonomous-cars-likely-to-increase-congestion-28009>

Autonomous cars likely to increase congestion

CleanTechnica

Congestion is a serious issue in developed countries, but autonomous cars are likely to be as much a part of the problem as part of the solution. Consider these US numbers from a study published in late 2015:

The top 30 bottlenecks are each responsible for more than one million hours of lost time annually. Drivers stuck on these roads experience total delays of about 91 million hours every year, the equivalent of 45,500 person-work years. The lost value of time to the economy from congestion just in this handful of locations is upwards of \$2.4 billion annually.

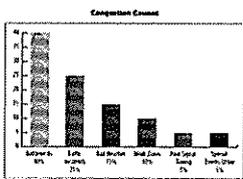

Many advocates frequently allude to traffic congestion as one of the key things which autonomous cars will help solve, but it's worth looking at the actual causes of congestion and how likely patterns of autonomous car use will play out in the real world. As this graphic from the US Department of Transport's 2012 Urban Congestion Trends report shows, 40% of congestion comes from bottlenecks. While there are other contributors, the biggest single contributor to bottlenecks is too many cars on the road. Almost everything that can be done to the roads will drive only marginal improvements, while increases in car miles traveled will have a direct and non-linear increase in congestion.

Typically, autonomous car advocates point to two elements which will definitely decrease congestion, but ignore the factors which are likely to increase it.

Reducing collisions reduces congestion — One major advantage of autonomous cars is that they won't get in accidents with anything like the frequency or severity of human-driven cars. This will reduce overall congestion, while also seriously reducing the number of auto body repair and paint shops required. But they will still get in collisions. The evidence on this is fairly clear:

The Insurance Institute for Highway Safety (IIHS) has seen a 7 percent reduction in crashes for vehicles with a basic forward-collision warning system, and a 14 to 15 percent reduction for those with automatic braking.

That's excellent, but the automatic braking is one of the primary collision avoidance tools for cars, and it achieves only 14% to 15%. Further, traffic collisions contribute only 25% to congestion. Solutions which decrease collisions but increase road miles traveled as well could have a larger impact with the road miles than with the collisions.

relaxing long drives, and the Tesla model has free Superchargers, so long-distance driving is becoming much cheaper and easier with autonomous cars. While many automotive theorists predict radical changes in human behaviour related to car ownership, there's little reason to believe that people will become rational just because of a new technology. There will be an impact on private vehicle ownership, but not nearly as big as some advocates suggest. And if this is the case, then there is little reason to expect a reduction in total car miles driven, the largest indicator of congestion.

Reduction in family vehicles increases total miles driven — While in general there is little reason to believe that there will be substantial decreases in ownership, let's explore that model, in case it comes true. Let's identify a model family of mother who works downtown, father who does piece work at home, and two children in school. In this model, the family's single autonomous car delivers the mother to work downtown, then swings back and takes the kids to school, then swings back and takes the father to a mid-day yoga class, then unspools this at the end of the day. This does take a two or maybe even three car family down to a one car family. Except it does it by up to doubling the total miles driven by the family, as the car goes two ways. Once again, congestion is strongly correlated to total miles driven by cars, and in this model an empty car is driving around with no one in it a lot of the time and the total miles driven by the family vehicle go up. That likely increases congestion.

Parking outside of the city core increases total miles driven — Right now people who drive to work park at or very close to work. That's pretty useful because they have access to their vehicle and it stops driving once they reach their destination. Under one model posited for autonomous cars, the car wanders away to cheap parking outside of the core. The problem with this is that it once again puts more vehicle miles on the car which is strongly correlated to increased overall congestion. Imagine a bunch of empty cars on the roads at rush hour trying to get through city streets to cheap parking.

Passenger comfort reduces intersection throughput — There's another downside to autonomous cars related to congestion. People mostly will want them to be as comfortable as trains, accelerating and decelerating smoothly. Studies have suggested strongly that this means that car behaviours will slow traffic through intersections, increasing passenger comfort at the expense of overall efficiency. This can be seen by the innumerable stories about Google Cars driving like short-sighted, very polite, very timid people who have all the time in the world. So in addition to intersections having a bunch more cars in them, many of them empty of all passengers, the autonomous vehicles, especially the ones with people in them, will be taking from 4% (best case) to 2000% longer to clear an intersection. While autonomous cars increase highway vehicle capacity, they could decrease intersection vehicle capacity by 18% to 53%.

Longer commutes become viable, increasing total miles driven — At present, commuting by car is highly unproductive time. Commuting by transit is also problematic due to lack of power outlets, WiFi, and ability to have private conversations. There's a model of the future, however, in which autonomous cars provide a private productivity zone, allowing people to live even further from work. Autonomous cars promoting suburban living and long commutes as a viable alternative increases traffic congestion, not the inverse.

Induced demand increases volume — Induced demand says that, after supply of something is increased, demand increases as well. This is a well understood economic behaviour that can be observed in efficiency programs and traffic. Study after study after study shows that when you increase road carrying capacity, the roads just fill up again.

Duranton and Turner say building more roads results in more driving for a number of reasons: People drive more when there are more roads to drive on, commercial driving and trucking increases with the number of roads, and, to a lesser extent, people migrate to areas with lots of roads. Given that new capacity just increases driving, they find that "a new lane kilometer of roadway diverts little traffic from other roads."

There is no reason to believe that increasing road carrying capacity due to autonomous cars being able to drive more closely together with fewer volume-induced slowdowns will not be subject to exactly the same

effect. Ignoring all other aspects of adoption, if more vehicles can get through a specific road segment in an hour, it will probably fill up to that maximum volume with resulting congestion bottlenecks reoccurring.

It's also worth, of course, pointing out that all of those additional vehicle miles would produce much more carbon and pollution emissions in the absence of any other changes. Thankfully, electric vehicles are leading the charge in this space, and there is a strong likelihood that significant penetrations of fully autonomous vehicles will match the necessary electrification of those vehicles.

Scenario	Collisions	Cost (\$)	Vehicle Miles	Travel Time (hr)
Baseline	100	100	100	100
Autonomous	60	60	150	100
Electric	60	60	150	100
Autonomous + Electric	36	36	150	100
Autonomous + Electric + EV	21	21	150	100
Autonomous + Electric + EV + EV	12	12	150	100
Autonomous + Electric + EV + EV + EV	7	7	150	100
Autonomous + Electric + EV + EV + EV + EV	4	4	150	100
Autonomous + Electric + EV + EV + EV + EV + EV	2	2	150	100

So, the traffic congestion scenario is not as rosy as many autonomous car proponents suggest. For the purposes of discussion, I've put together some projections of different scenarios. In each, I've reduced collisions by 40%. Most other factors don't change, bottlenecks due to volume swings substantially with increased vehicle miles and the non-linear effects discussed earlier.

At best, the greater number of cars which would be able to get through a given point without congestion ensuing would be consumed by the greater number of cars both full and empty driving through that point on average. This is behaviour which is remarkably similar to building new roads, in that relief from congestion is always temporary. "If you build it, they will come" is the reality of traffic. In this scenario, there is still some benefit from reduced collisions, so overall traffic is better.

In the median scenario, all benefits from reduced accidents are consumed by greater numbers of vehicles on the road, leading to exactly the same amount of congestion as before, just balanced to more cars rather than more collisions.

And in the worst case, there's a potential for much worse congestion due to all of the vehicles on the roads.

As I look across all of the systemic implications of autonomous cars, I see equal or greater congestion on our roads, not less, and more societal negative externalities than advantages. Autonomous vehicles are not a silver bullet for traffic problems. They are coming, and as a person who drives, I welcome them, but good policy and adaptation to the transformation requires clear eyes.

RenewEconomy Free Daily Newsletter

Attachments

- Screen-Shot-2016-01-14-at-1.20.09-PM-270x192.png (27.07 KB)
- Screen-Shot-2016-01-14-at-1.37.52-PM-270x182.png (22.00 KB)
- car-van-suv-trunk-organizer-groceries-sports-equipment-tools-storage-camping-new_2116113-270x180.jpg (17.53 KB)
- Screen-Shot-2016-01-14-at-2.14.27-PM-270x92.png (4.34 KB)

Subject: RE: Introduction

From: Alan Pears [Sch 4 CTPI]

To: [Sch 4 CTPI] mangocube6@yahoo.co.uk;

Date: Wednesday, 20 January 2016, 16:41

Thanks [Sch 4 CTPI] Sounds interesting. In Oct-Nov I was in Asia speaking at the APEC Energy Ministers conf and an ASEAN energy summit! I'm also on the Vic govt reference panel for their Energy Efficiency and Productivity Strategy which will be released in the next few months.

I've attached my ppt and speaking notes on the future role of clean energy from the APEC Ministers session which may be useful - public documents.

I'm away from 12 to 27 Feb but around apart from that. Happy to help however I can.

Alan P

[Redacted signature block containing Sch 4 CTPI]

-----Original Message-----

From: [Sch 4 CTPI]

Sent: Wednesday, 20 January 2016 9:41 AM

To: Mark Bailey <mangocube6@yahoo.co.uk>

Cc: alan Pears [Sch 4 CTPI]

Subject: Introduction

Hi Mark,

I am introducing you to Alan Pears, who can help guide you with energy policy. Alan is the 'expert's expert' on efficiency and renewables with extensive experience at the State and Federal levels.

His contact numbers are: mob: [NR] home: [Sch 4 CTPI]

Alan, Mark is the Minister for Energy (and 4 other portfolios) in the Queensland government and one of the new breed of parliamentarians who understands the need and opportunity of clean energy. Please assist in whatever way you can. This email address is his private account and he can direct you how best to communicate.

Please let me know if I can be of further assistance.

Best,

[Redacted signature block containing Sch 4 CTPI]

Attachments

- APEC TALK 13 Oct pics and notes revised.pdf (989.44 KB)
- APEC Philippines talk Pears final Oct 2015.pdf (1.29 MB)

APEC TALK 13 Oct pics and notes



Our efficient, smart, flexible, distributed and diverse energy future

Reception at APEC Energy Summit, November 13, October 2015

Minister for Energy

Speech by the Hon. Minister for Energy, the Hon. Minister for Industry and Science, the Hon. Minister for Trade and Export Promotion, the Hon. Minister for Transport, the Hon. Minister for the Environment and the Hon. Minister for the Arts, Culture and Heritage

Efficient energy efficiency transitions are critical to a sustainable world. Our energy future will be shaped by the technologies and services that we develop and use.

Good afternoon distinguished Ministers and delegates. I would like to thank APEC and the Philippine government for the opportunity to speak to you, and for looking after me so well while I have been here.

In my talk, I will outline my thoughts on clean energy options, and suggest some options for APEC action. I will not attempt to go through my slides in detail. Instead I will summarise key messages.

We live in a time of astounding change, illustrated by examples like the extreme energy efficiency of this 138 km/h Human Powered Vehicle, as well as smart phones and many other innovations. These innovations are transforming our thinking about everything in our lives – including energy.

Change in energy reflects broader disruptive changes in technology and society, such as:

- Internet, virtual solutions, dematerialisation
 - Green chemistry and alternatives to process heat
 - New materials – nanotech, graphene etc
 - Computational design, virtual manufacturing
 - Additive manufacturing technologies, 3-D printing etc
 - Robotics
 - Growth of services economy
 - Smart services
- Energy resources industries are among the first to face disruptive structure change and major substitution risk

Indeed, it is important to recognise that many changes in the energy sector are being driven by technology, social change and innovation across industry, business and society.

Key Energy Drivers

- Our 'need' for energy flows from 'needs' for services like nutrition or economic output and the materials, products, services and business models used to satisfy them
- Recent innovation dramatically increases options to satisfy 'needs' – substitution by radically different alternatives
- These involve integrated use of combinations of:
 - Innovative reframing of what our needs are (eg virtual solutions)
 - Devised business models, markets and technology supply chains
 - More efficient energy and resource use
 - Smart management of demand
 - Storage of energy in many forms (heat, coolth, electricity, chemical, gravitational potential, movement)
 - Distributed and decentralised energy production or conversion

We must keep in mind that our energy requirements flow from the services people and business want, and how they interpret their needs. Energy is just one, admittedly important, input into complex services. People and businesses do not want energy for its own sake.

Recent developments have allowed consumers of services to substitute other ways of providing their needs that involve very different energy inputs. We have moved from a fairly simple, linear energy supply model to many options that interact in complex ways.

If we are to respond effectively, we must look at these as integrated systems, not individual technologies or business models. They work together.

The 'energy' service delivery system – many options of very different kinds now exist and compete in different markets

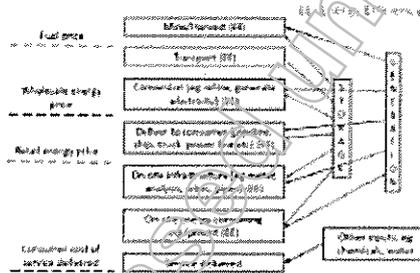

In this slide I have tried to summarise an emerging energy model.

First, we see that much of the infrastructure investment is on the consumer side of the meter.

And the price that a given technology competes with varies with its location in the system.

Indeed, a consumer will make decisions not on the energy price or cost, but on the total cost of delivery of a service relative to the value they perceive they will gain from that service.

Energy efficiency measures (shown in green), which often also reduce peak energy demand, can apply at any point in the system – driven by quite different factors, only one of which is energy cost.

Similarly storage, which frees us from the need to match supply and demand in near real time, and energy generation/conversion can also occur at any point in the system. So the conventional energy price they compete against also varies. I have often been puzzled by graphs in energy studies that compare the cost of rooftop solar and coal-fired electricity at the power station. They compete in completely different markets and against very different electricity prices.

Diverse energy service solutions are emerging. Centralised systems still have a role, but distributed ones are gaining. Combinations of solutions often work best, and there will be ongoing transition.

Feature	Traditional	Emerging
Scale of production	Through larger size	Through mass production
Flexibility of rollout	Fixed	Large
Capital required, risk, subsidies	Large lump, long-term, indivisible spending	Small lumps, early cash flow, modular investment
Commission and learning curve experience	Slow	Fast, from diverse markets and technologies
Planning, construction, performance	Long, fixed flexibility	Short, competitive
Resource availability	Fossil fuels, dams	Renewable energy, diverse water sources, and low technologies
Readiness to follow changing worldviews	Fixed	Diversifying, ready to change
Geographical, social, political	Local, regional, global	Local, suited to local conditions
Overall system efficiency	Significant losses in conversion, distribution	Variable - new point of view, no comparison point

Many (but not all) emerging energy solutions are more like cars or appliances than traditional energy technologies. They are modular and distributed, not centralised.

They gain economies of scale through mass production, not size, and the learning curve can be very fast, based on early field experience.

The rate of roll-out can be adjusted to conditions, and they can generate cash flows sooner because each unit starts working as soon as it is installed.

These, and other features in this table, make them nimble. In contrast, traditional large scale energy systems are slow to change.

This difference partly explains why we are seeing so many surprises.

I will now look at some practical examples of how emerging new energy solutions can drive change.

Example – Cold Storage:

University of South Australia / Glaxim demonstration project

Potential Integrated Energy Solution

Key energy efficiency

- Building heat reflective paint (insulation, air lock)
- High efficiency chillers, smart controls (to the energy storage)
- Thermal (possibly using phase change materials - PCM)
- Electricity

On site energy production

- Rooftop solar PV
- Use waste (other heat to distilleries, stock feed (dewatering water))

Thermal storage

- Optimised energy management
- Optimised operating time
- Customised exports and imports of electricity
- Maybe go off grid or microgrid?
- Maybe cooperate with other local generation, storage and energy users?

100 kW Solar generation system

- 4.4 MWh of thermal storage (24 hours) and 200 kWh of solar PV planned
- 200 kWh for each storage and PV

This experimental cold storage facility is already using less energy from the grid and has lower peak electricity demand by using energy efficiency, thermal storage and (soon) rooftop solar. And it's making more profit at the same time, through a 20% pa internal rate of return on these investments.

It has many more options to transform its energy management, as shown.

Aluminium smelting: strategies and research projects to cut energy use

- **Big picture options to cut aluminium energy use per unit service.**
 - 'Virtual' solutions replace physical ones
 - Design of products for optimal material use
 - High strength alloys, 3D printing use less material
 - Switch to other materials, eg carbon fibre
 - Use recycled aluminium
- **R&D, eg ARPA-E projects (US government R&D program)**
 - **Alcoa:** heat exchanger (using molten glass or salt) built into pot casing (improves insulation, provides flexibility in electricity demand (using heat storage), improved electrodes – **50% saving target**
 - **Gas Technology Institute:** use reusable solvents (thermal dissolution) at near room temperature; could be located near bauxite mines – **44% cost reduction target**
 - **Infinium:** new electrochemical cell, much better insulated and high value by product (pure oxygen), drop in retrofit – **50% net saving target**
- **Shift to renewable electricity**

Aluminium smelting is just one example of a traditional high temperature, energy intensive process served by large baseload power generation. But this could change.

First there are increasing options to substitute demand away from virgin aluminium.

Second, research such as these projects funded by the US government, could transform the amount, energy source and timing of energy requirements.

Industrial steam

- Avoid use of steam (use heat pumps instead) (18 addition, dependent on fuel)
- Advanced high temperature heat pump (up to 1650°)
- Modular hot water or steam generators
- Renewable heat sources
- District heat or district cold

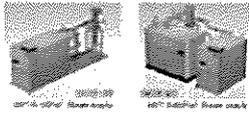

• Can give renewable electricity



Right-hand (top) part: Heat pump



Left-hand (bottom) part: Steam turbine



Fig. 1.18 Process flow diagram of a 100 MW boiler system (from [18] with permission of industrial heat pump, Year 2010)

A boiler producing steam that is distributed around a site is a common 'workhorse' in industry. But like the horse did, it faces competition from many new technologies, including new chemistries that lower process temperatures as well as the advanced Japanese heat pumps and thermal storage shown here.

In some ways the boiler can be compared with the central steam engine that used to drive all the separate machinery in factories using shafts and pulleys.

Residential: Technology transformation

(Based on recent presentation to Japanese ASSE Workshop, April 2014)

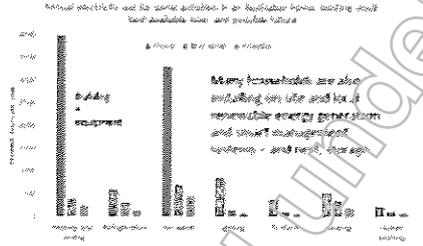

In homes, we are finding that new technologies combining elements, such as the building shell and the heating or cooling system, can deliver very large savings relative to the average existing situation: and even larger savings relative to the most inefficient homes.

Replacing or upgrading existing stock of inefficient appliances and buildings can free up surprising amounts of existing energy supply capacity to cope with population growth and (efficient) economic development.

Energy policy tools

- Strategies and targets – visions
- Information, promotion, training
- Voluntary agreements, public reporting
- Regulation, standards
- Taxes and levies, pricing
- Incentives, subsidies and financial facilitation
- Market mechanisms
- Innovation, R&D, commercialisation
- Government purchase and example
- Institutional frameworks and resourcing
- Managing access to markets and resources
- Management of perceived risks and opportunities
- Other policies adapted to achieve energy goals too

I'm not going to talk about the wide range of policy tools available to the energy sector: but we do tend to under-use some of them: we need to take broader policy approaches, including using packages of tools more.

We also need to engage much more with other sectors, so that policies not directly focused on energy, but which influence energy use, also help to address our energy issues. Building policy, social welfare policies, traffic congestion management and business innovation are just a few examples.

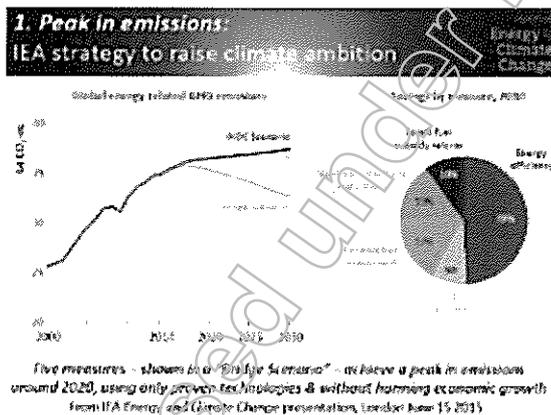

Looking at specific policies, the International Energy Agency has done some excellent work in this area. This recent slide of theirs summarises their policy priorities to drive down climate impacts. Note that energy efficiency is half of the game, and much bigger than renewable energy. Yet our energy policy institutional structures don't always reflect that.

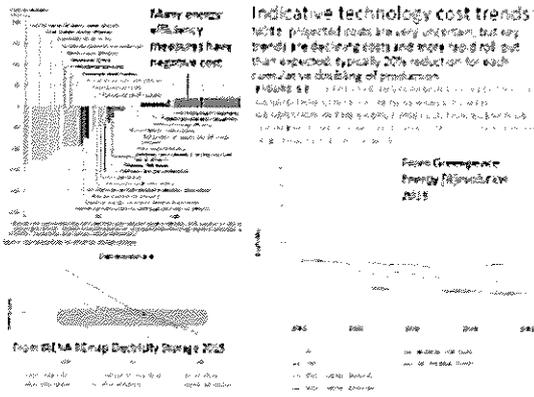

If we look at costs, and cost trends for emerging energy solutions, we find a wide range of views, depending on differing assumptions and local circumstances. But the common threads are:

- There is a lot of negative cost (that is beneficial) opportunity, much of it in energy efficiency and smart management
- Most emerging technologies are becoming cheaper and working better
- These trends are expected to continue and may accelerate –especially if we encourage them!

Evaluation of Costs and Benefits

- Sophisticated evaluation of cost-effectiveness must consider many factors:
 - Local circumstances
 - What price does it compete with: wholesale, retail energy price? And what will those prices be?
 - For efficiency measures, what total service cost does it compete with?
 - What non-energy market(s) does it compete in?
 - What other costs does it avoid: avoided infrastructure costs; distribution/delivery costs and losses; peak loads
 - What other benefits: avoided blackouts, improved productivity, health, product quality etc (see IEA *Multiple Benefits of EE* report), benefits for disadvantaged groups
 - Impacts on total level of energy subsidies, energy security, social systems
 - Impact of likely future levels of carbon prices or equivalent policies on cost relative to competitors

A major barrier to emerging energy solutions is narrow, short-term focused economic analysis. We need to consider the complex range of circumstances, and include the multiple benefits identified by the IEA and others. We need to understand the synergies captured as new solutions interact with and help each other.

My remaining slides focus on what APEC could do to support our emerging energy revolution.

Where to Now for APEC?

- **No-one knows which options will be winners, so we need:**
 - Flexible strategies, quality information and detailed monitoring of change
 - To encourage innovation, trials, knowledge sharing, creative finance models
 - To support emerging options to compete with powerful incumbent businesses
 - To manage disruption, inefficiencies and mistakes
- **Different solutions will be best in different circumstances, depending on service requirements, available options and local cultures and policies**
- **There will be winners and (often powerful and noisy) losers**
- **Climate response and adaptation will be overarching drivers**

I don't think anyone can predict our energy future at the moment. There is just too much happening. We need to be flexible and not just responsive, but proactive. We need to imagine the unimaginable and develop ways of managing it.

We need to recognise that climate change is an overarching driver of change – and communities are becoming impatient with the energy sector and governments.

So here are some suggestions:

NOTE: refer to 'member economies' not countries

APEC Actions?

- **Encourage APEC members to develop and implement energy strategies that:**
 - Are consistent with decarbonisation by 2050 or earlier
 - Are flexible and adaptable to unexpected changes, innovation
 - Factor into energy option evaluation factors such as rethinking of 'energy needs', economies of scale, learning by doing, 'multiple benefits', innovation in and from other sectors, etc
 - Incorporate clean energy elements into policies across the economy and society (eg housing, social welfare, taxation)
- **Work with member countries, IEA etc to:**
 - Track and share actual costs, benefits, experience and progress of emerging technologies and underlying policies and measures
 - Develop, trial and implement planning methodologies, institutional arrangements and funding systems (eg through ABAC) that support integrated energy solutions
- **Ensure emerging technologies are not blocked by institutional inertia or incumbent power**

Key measures will involve:

- Facilitating innovation and action across all sectors of APEC member economies to support integrated energy solutions
- Creative financing mechanisms
- Overcoming institutional inertia and incumbent power.

My final slide is not just about the geothermal potential shown in the slide. It is intended to highlight the likelihood that global energy trade will also be transformed by new energy –. This transformation will be great for the energy security and balance of payments of energy importers, but it creates new challenges for existing energy exporters.

THANKYOU FOR YOUR TIME. I HOPE I HAVE PROVIDED A WINDOW INTO AN EXCITING ENERGY FUTURE. I look forward to our discussion.

Released under RTI Act 2002

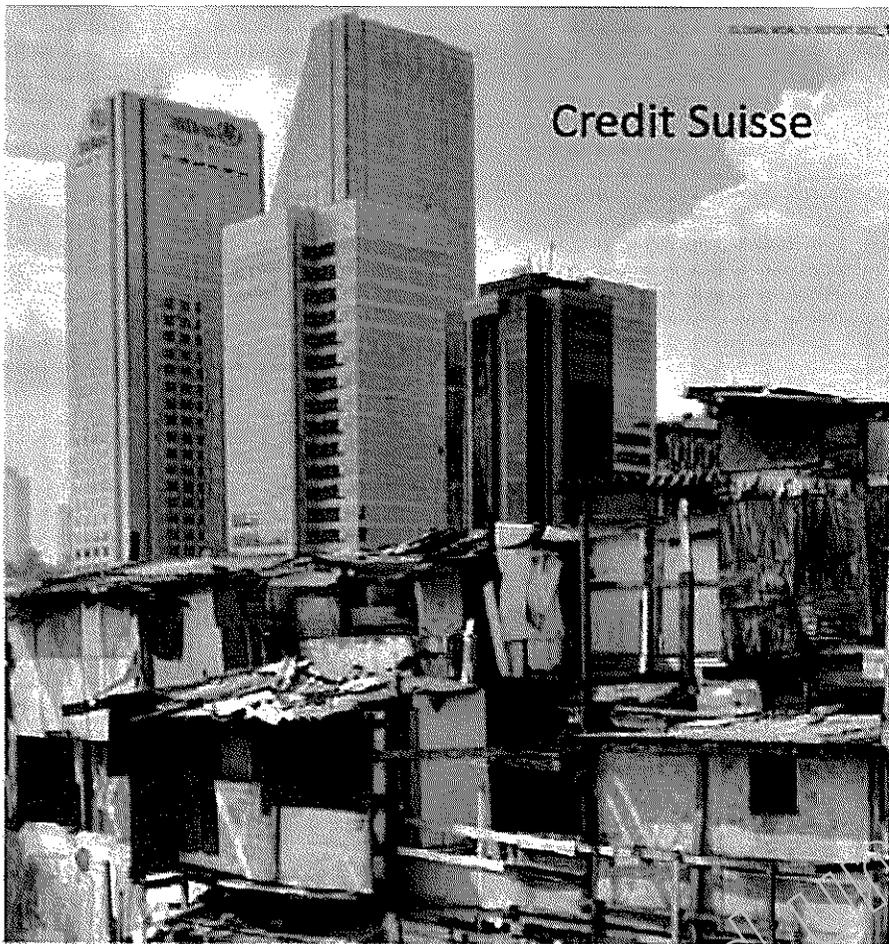

Credit Suisse

Our efficient, smart, flexible, distributed and diverse energy future

Presentation at APEC Energy
Ministers' Meeting 13 October 2015

Alan Pears AM

Senior Industry Fellow RMIT
University, Melbourne Australia
Associate Consultant Buro North



Extreme energy efficiency transforms our thinking
about reality: world record holding human
powered vehicle – 137.9 km/h

<http://gosporttimes.com/2015/09/20/crazy-fast-human-powered-vehicle-sets-new-world-speed-record/>

Change in energy reflects broader disruptive changes in technology and society such as:

- Internet, 'virtual' solutions, dematerialisation
 - Green chemistry and alternatives to process heat
 - New materials – nanotech, graphene etc
 - Computerised design, control, monitoring
 - Modular, decentralised technologies, 3-D printing etc
 - Urbanisation
 - Growth of services economy
 - Globalisation
-
- Energy, resources industries are among the last to face culturally disruptive change and major 'substitution' risk

Key Energy Drivers

- Our 'need' for energy flows from 'needs' for services like nutrition or economic output and the materials, products, services and business models used to satisfy them
- Recent innovation dramatically increases options to satisfy 'needs' – **substitution** by radically different alternatives
- These involve *integrated* use of combinations of:
 - Innovative reframing of what our needs are (eg virtual solutions)
 - Diverse business models, markets and technology supply chains
 - More efficient energy and resource use
 - Smart management of demand
 - Storage of energy in many forms (heat, coolth, electricity, chemical, gravitational potential, movement)
 - Distributed and diversified energy production or conversion

The 'energy' service delivery system – many options of very different kinds now exist and compete in different markets.

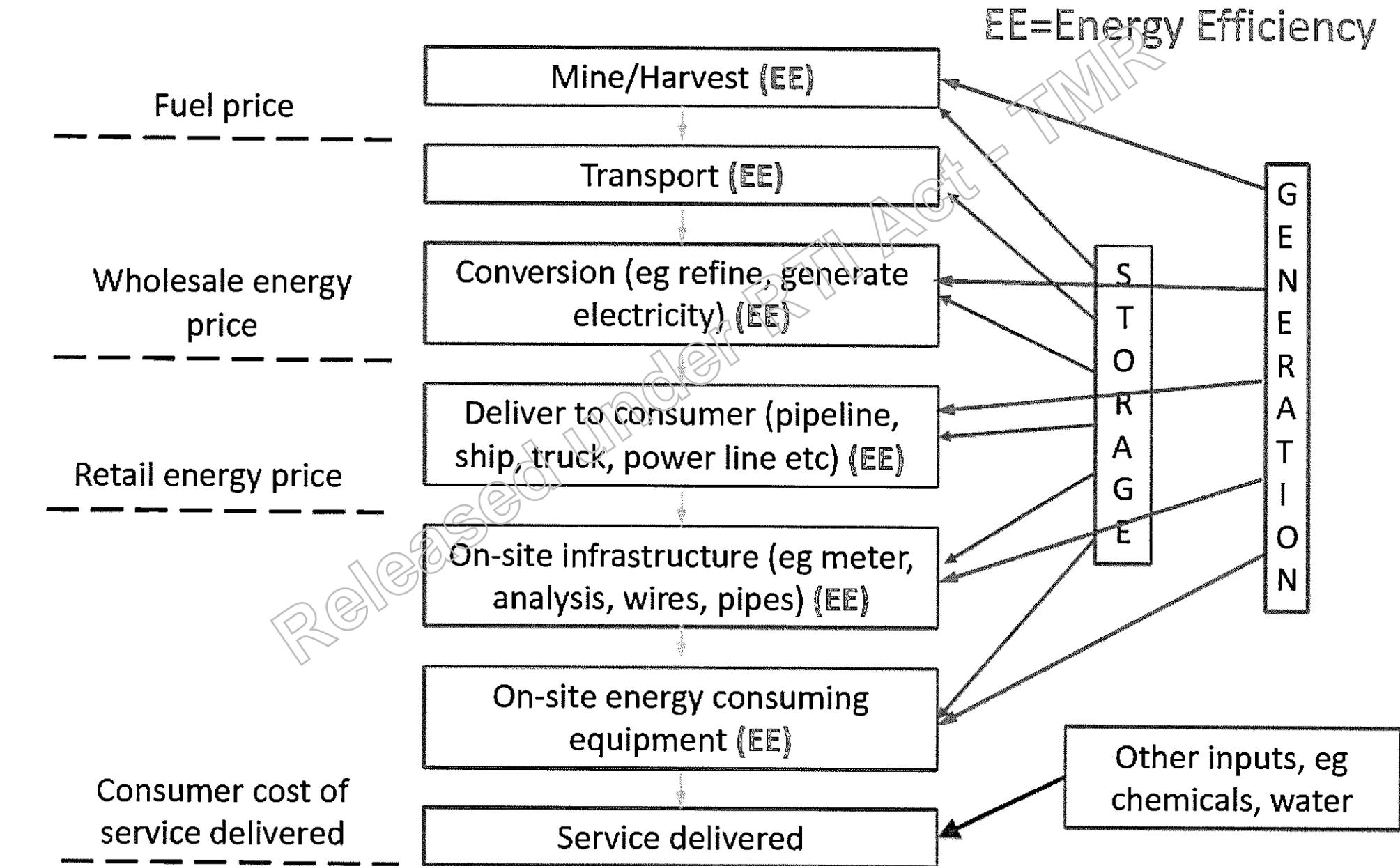

Diverse energy service solutions are emerging. Centralised systems still have a role, but distributed ones are gaining. Combinations of solutions often work best, and there will be ongoing transition

FACTOR	CENTRALISED	DISTRIBUTED
Economies of scale	Through larger size	Through mass production
Flexibility of roll-out	Limited	Large
Capital required, risk, subsidies	Large lumps, long-term, subsidies on-going	Small lumps, early cash flow, subsidies up-front
Innovation and 'learning from experience'	Slow	Fast, from diverse markets and technologies
Planning, construction timeframes	Long, limited flexibility	Short, responsive
Resource suitability	Fossil fuels, dams	Renewable energy, diverse water sources, end-use technologies
Resilience to failures, changing conditions	Limited	Diversity, modularity help
Environmental, social impacts	Local, regional, global	Local, linked to beneficiaries
Overall system efficiency	Significant losses in conversion, distribution	Variable – near point of use, so consumer pays

Example – Cold Storage:

University of South Australia / Glaciem demonstration project

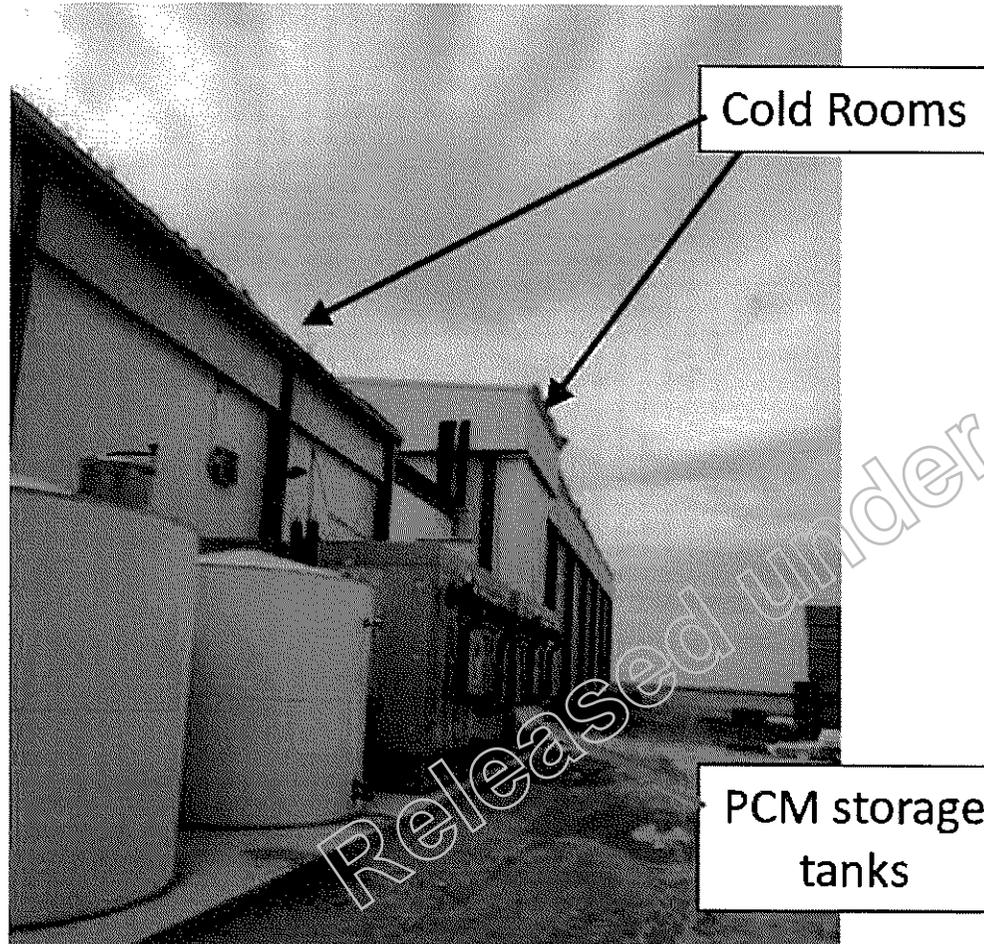

Potential Integrated Energy Solution

On-site energy efficiency:

- Building: heat reflective paint, insulation, air locks
- High efficiency chillers, smart controls

On-site energy storage:

- Thermal ('coolth' using phase change materials - PCMs)
- Electricity

On-site energy production:

- Rooftop solar PV
- Use waste chiller heat to dehumidify, cool, heat (eg cleaning water)

Integrated energy management

- Optimise operating cost
- Optimise exports and imports of electricity
- Maybe go 'off-grid' or micro-grid?
- Maybe cooperate with other local generation, storage and energy users?

- 120 kWe Refrigeration system
- 1.4 MWhrs e thermal storage (1% floor area)
- 200 kWp of solar PV planned
- 20% IRR for both storage and PV

1. Peak in emissions: IEA strategy to raise climate ambition

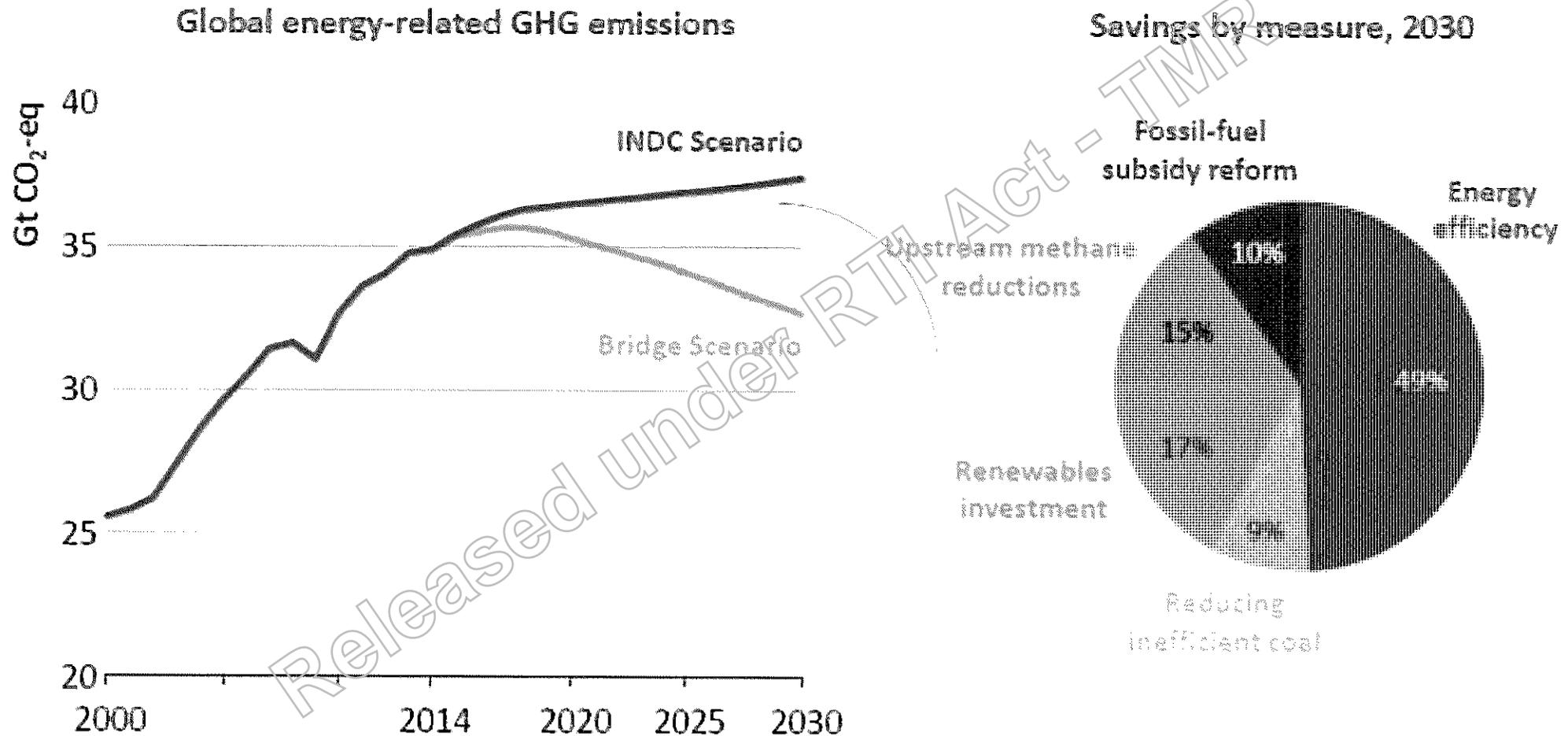

Five measures – shown in a “Bridge Scenario” – achieve a peak in emissions around 2020, using only proven technologies & without harming economic growth

From IEA *Energy and Climate Change* presentation, London June 15 2015

Aluminium smelting: strategies and research projects to cut energy use

- Big picture options to cut aluminium energy use per unit service:
 - ‘virtual’ solutions replace physical ones
 - Design of products for optimal material use
 - High strength alloys, 3-D printing use less material
 - Switch to other materials, eg carbon fibre
 - Use recycled aluminium
- R&D, eg ARPA-E projects (US government R&D program)
 - **Alcoa:** heat exchanger (using molten glass or salt) built-into pot casing improves insulation, provides flexibility in electricity demand (using heat storage); improved electrodes – **50% saving target**
 - **Gas Technology Institute:** use reusable solvents (chemical dissolution) at near room temperature; could be located near bauxite mines – **44% cost reduction target**
 - **Infinium:** new electrochemical cell, much better insulated and high value by-product (pure oxygen); drop-in retrofit – **50% net saving target**
- Shift to renewable electricity

Aluminium
smelting uses
3.3% of global
electricity

Industrial steam

- Avoid use of steam: centrifuge, microfiltration, depressurisation*
- Advanced high temperature heat pump (up to 165C)*
- Modular hot water or steam generator*
- Renewable heat sources
- Storage (heat or electricity)

* Can use renewable electricity

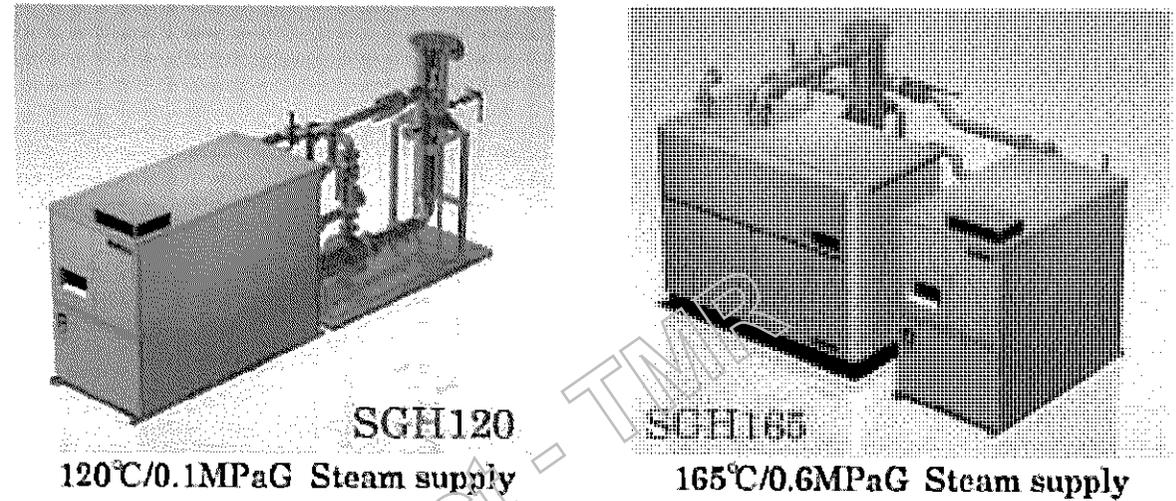
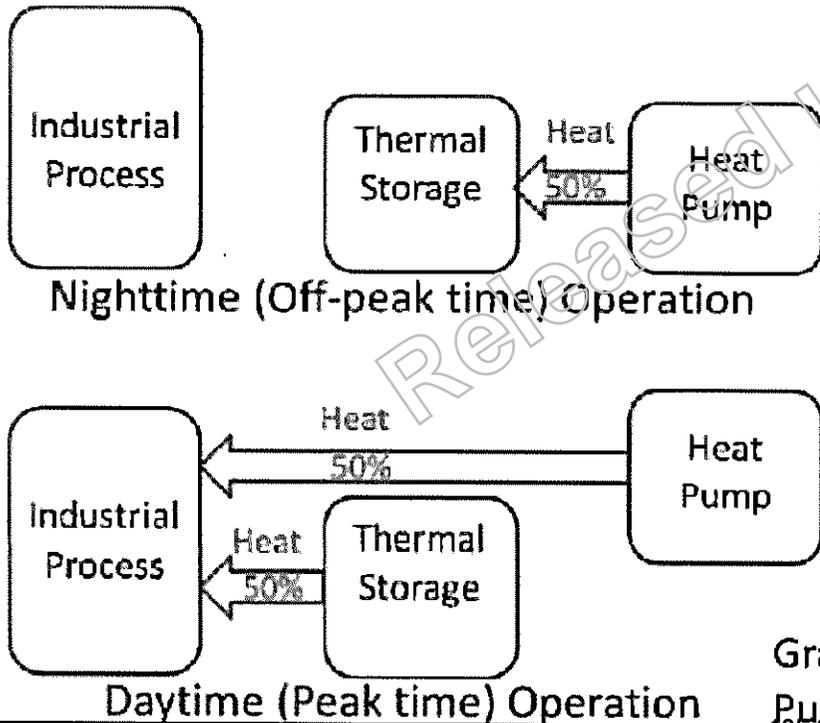

Fig. 2.3.2 Overview of system (KOBELCO: SGH series)

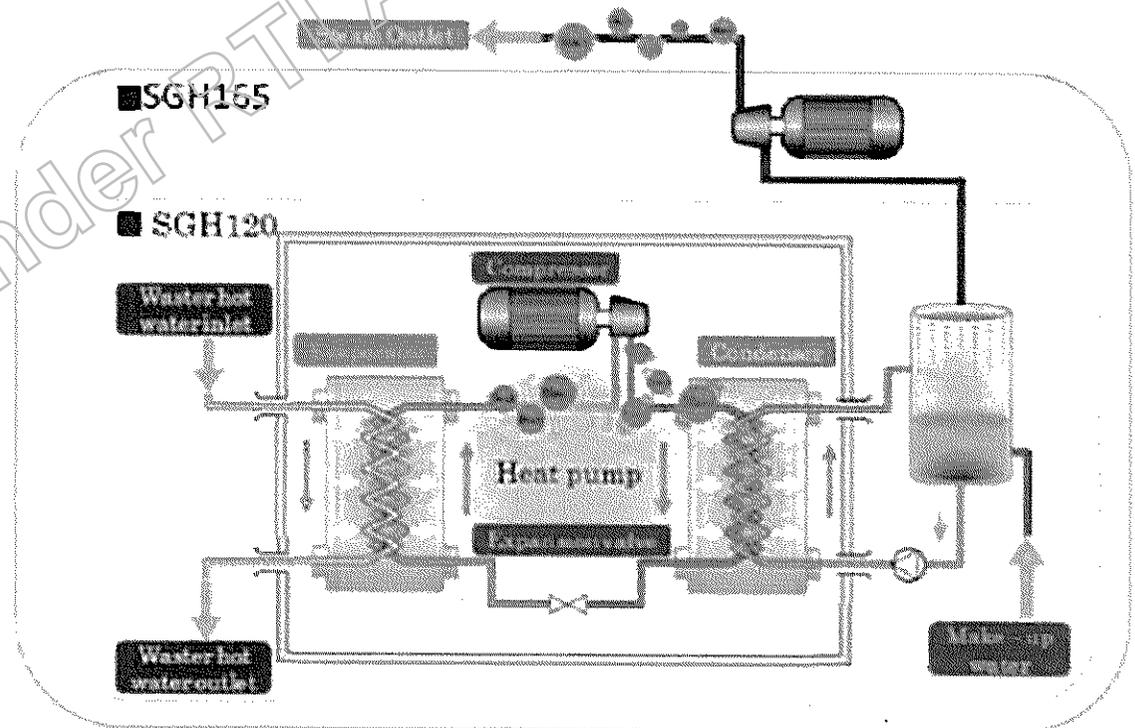

Fig. 2.3.1 System flow (KOBELCO: SGH series)

Graphics from IEA HPP Annex 35 Application of Industrial Heat Pumps, Task 3 (2013)

Residential: Technology transformation

(Based on Pears presentation to Sydney A2SE Workshop, April 2014)

Annual electricity use for some activities in an Australian home: existing stock; best available now; and possible future

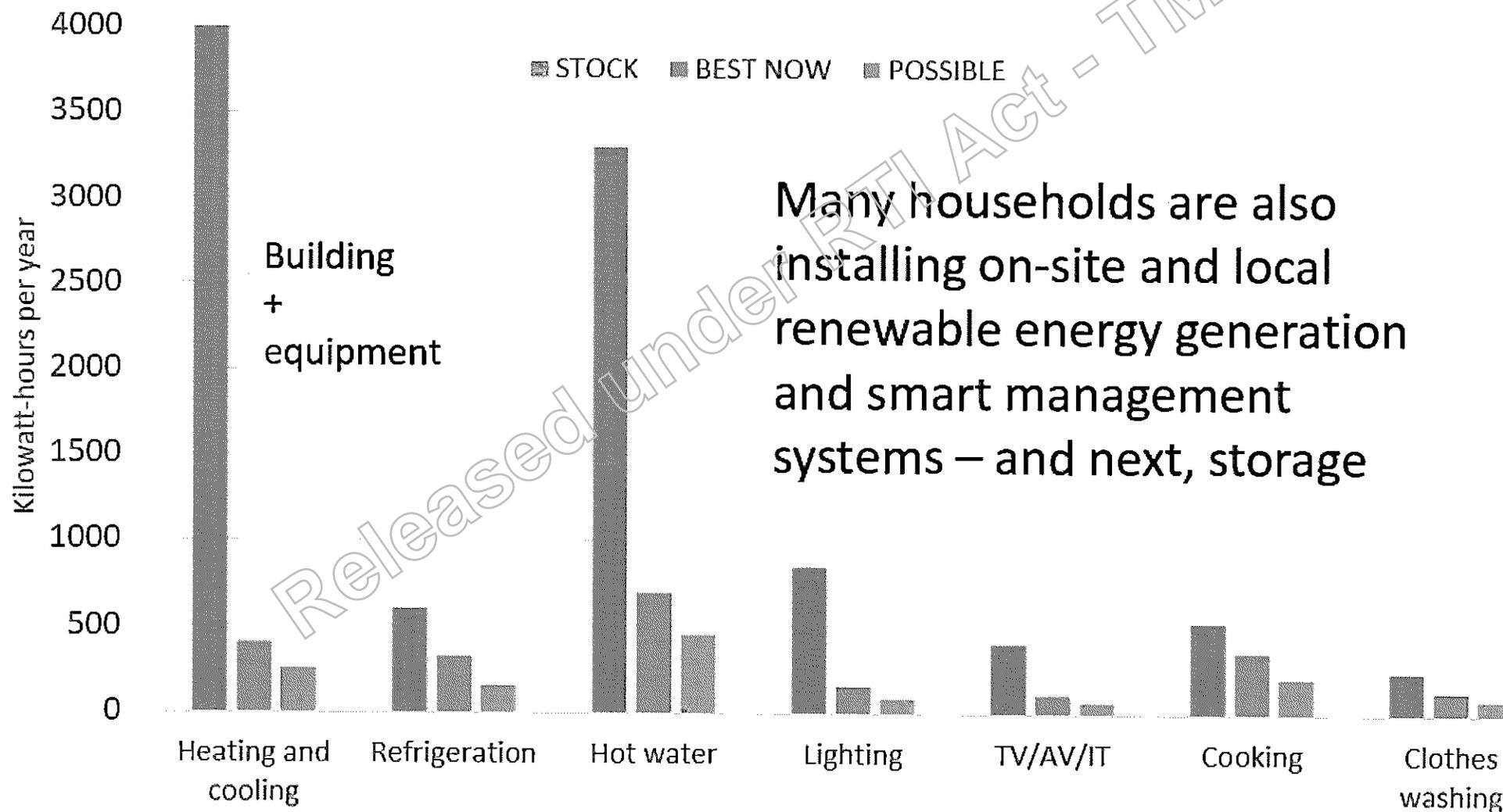

Released under RTI Act - TMR

Many households are also installing on-site and local renewable energy generation and smart management systems – and next, storage

Energy policy tools

- Strategies and targets – visions
- Information, promotion, training
- Voluntary agreements, public reporting
- Regulation, standards
- Taxes and levies, pricing
- Incentives, subsidies and financial facilitation
- Market mechanisms
- Innovation, RD&D, commercialisation
- Government purchase and example
- Institutional frameworks and resourcing
- Managing access to markets and resources
- Management of perceived risks and opportunities
- **Other policies adapted to achieve energy goals too**

Cost to society
ASPCO_e

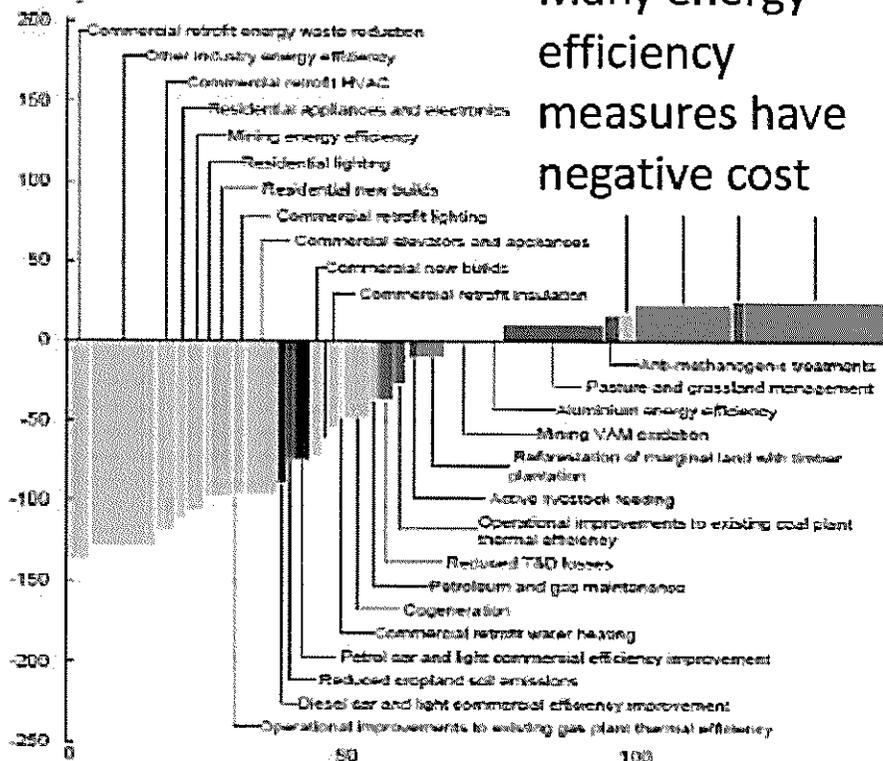

Many energy efficiency measures have negative cost

1. Includes only opportunities required to reach emission reduction target of 240 Mtpa (25% reduction on 2000) a consumption decision, changes in business/activity mix, and opportunities with a high degree of speculation.
SOURCE: ClimateWorks team analysis (refer to bibliography)

Figure 2: Cost assessments for electricity storage systems

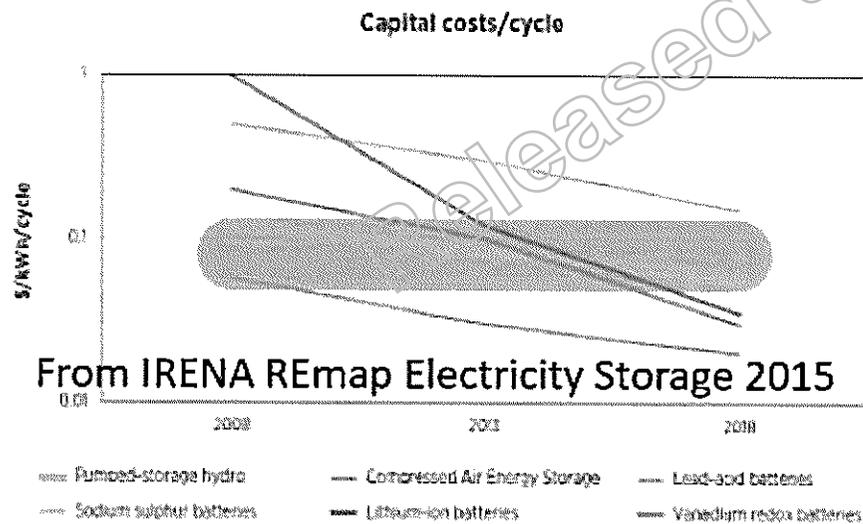

From IRENA REmap Electricity Storage 2015

Indicative technology cost trends:

NOTE: projected costs are very uncertain, but key trends are declining costs and more rapid roll-out than expected: typically 20% reduction for each cumulative doubling of production

FIGURE 5.2 : EXPECTED DEVELOPMENT OF ELECTRICITY GENERATION COSTS FROM RENEWABLE POWER GENERATION IN THE ENERGY [R]EVOLUTION SCENARIOS DEPENDING ON THE ASSUMED DEVELOPMENT OF FULL LOAD HOURS PER YEAR. EXAMPLE FOR OECD EUROPE

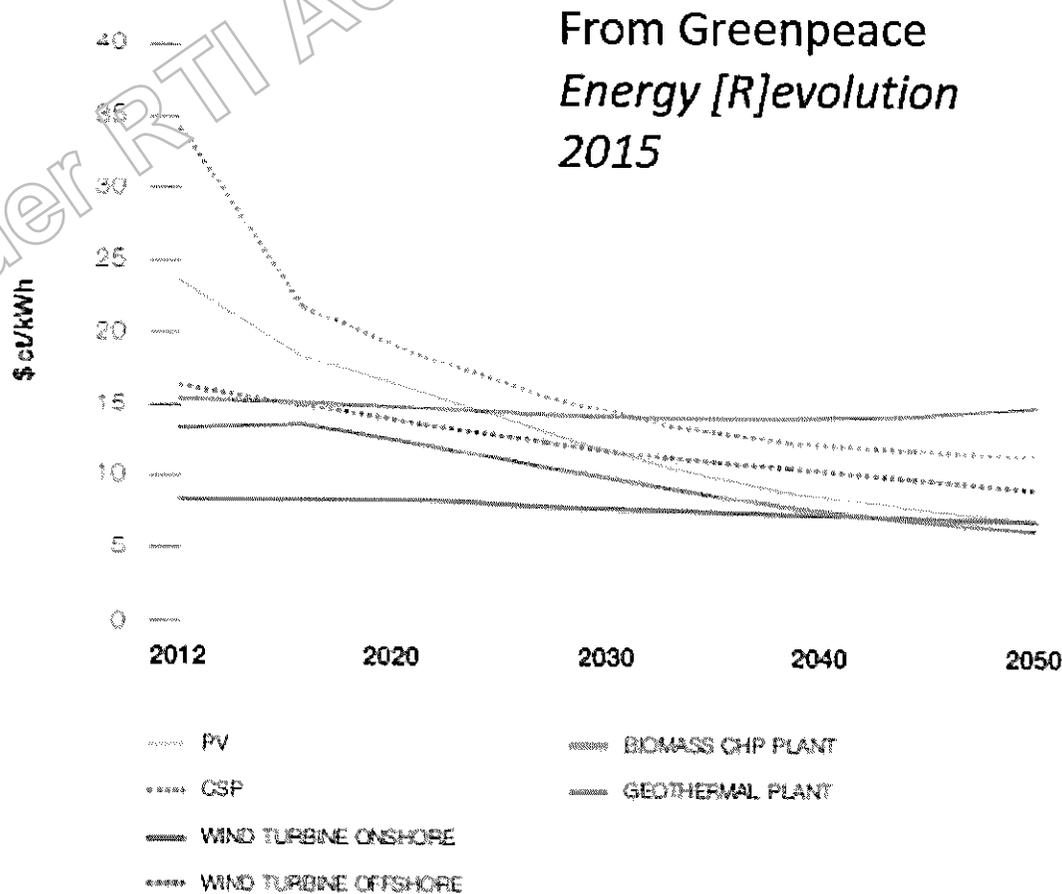

From Greenpeace
Energy [R]evolution
2015

Evaluation of Costs and Benefits

- Sophisticated evaluation of cost-effectiveness must consider many factors:
 - Local circumstances
 - What price does it compete with: wholesale, retail energy price? And what will those prices be?
 - For efficiency measures, what total service cost does it compete with?
 - What non-energy market(s) does it compete in?
 - What other costs does it avoid: avoided infrastructure costs; distribution/delivery costs and losses; peak loads
 - What other benefits: avoided blackouts; improved productivity, health, product quality etc (see IEA *Multiple Benefits of EE* report); benefits for rural and other disadvantaged groups
 - Impacts on total level of energy subsidies, energy security, social systems
 - Impact of likely future levels of carbon prices or equivalent policies on cost relative to competitors

Where to Now for APEC?

- No-one knows which options will be winners, so we need:
 - Flexible strategies, quality information and detailed monitoring of change
 - To encourage innovation, trials, knowledge sharing, creative finance models
 - To support emerging options to compete with powerful incumbent businesses
 - To manage disruption, inefficiencies and mistakes
- Different solutions will be best in different circumstances, depending on service requirements, available options and local cultures and policies
- There will be winners and (often powerful and noisy) losers
- Climate response and adaptation will be overarching drivers

APEC Actions?

- Encourage APEC members to develop and implement energy strategies that:
 - Are consistent with decarbonisation by 2050 or earlier
 - Are flexible and adaptable to unexpected changes, innovation
 - Factor into energy option evaluation factors such as reframing of 'energy needs', economies of scale, learning by doing, 'multiple benefits', innovation in and from other sectors, etc
 - Incorporate clean energy elements into policies across the economy and society (eg housing, social welfare, taxation)
- Work with member countries, IEA etc to:
 - Track and share actual costs, benefits, experience and progress of emerging technologies and underlying policies and measures
 - Develop, trial and implement planning methodologies, institutional arrangements and funding systems (eg through ABAC) that support integrated energy solutions
- Ensure emerging technologies are not blocked by institutional inertia or incumbent power

The international energy scene will change

Will new 'energy giants' emerge, eg countries leading in smart, efficient energy solutions; with major renewable energy resources such as solar, geothermal resources using advanced drilling techniques from the oil industry?

Source: <http://pubs.usgs.gov/gip/dynamic/fire.html>

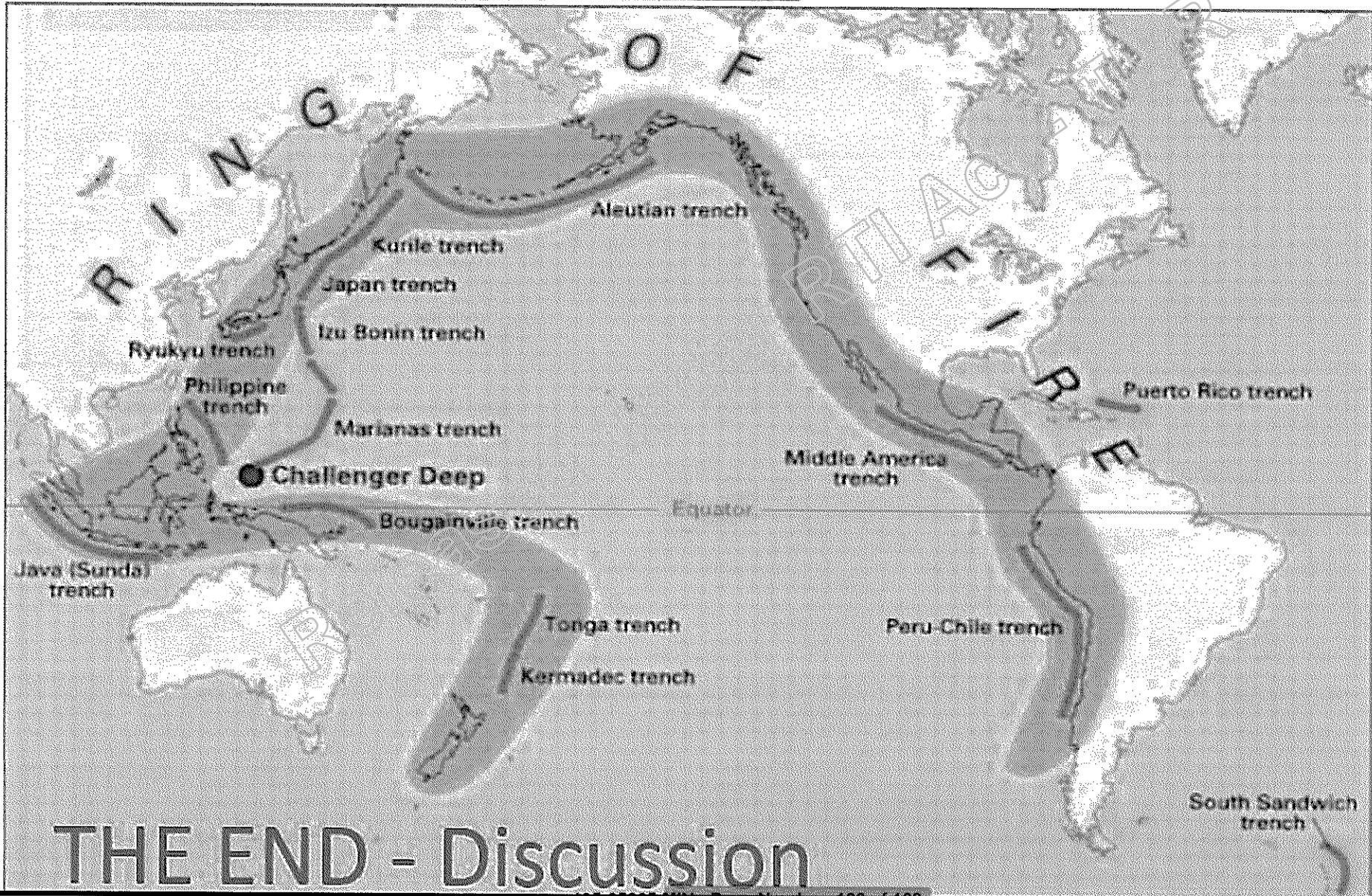

Subject: Meeting with Mark Leckenby and Energy Maximiser technology, and a QLD FIT/battery idea
From: Sch 4 CTPI
To: mangocube6@yahoo.co.uk;
Date: Wednesday, 20 January 2016, 9:01

Hi again,

As per our conversation, Mark Leckenby can brief you on his work with Energex and Ergon and the technology he has developed over the past decade to monitor and control electricity use in homes, offices and factories. I would like to attend as well. His company is called Enopte and as full disclosure my super fund has assisted Enopte with development loans. Enopte also has a number of solar battery installations

His box of 'magic' could really help the networks be much more efficient.

Just on that and following up on the battery ideas, here is one that might be worth exploring:

First, the 200K solar homeowners with the Qld FIT at 44 cents should not be penalised for being 'first movers'. And to be fair, there would only be about 100,000 if the previous govt was more thoughtful - you advisor pointed out to me that the numbers doubled in the last two weeks of the scheme when it was announced to be closed.

In any event, these owners took a risk and even though their systems may be paid for, their return is not guaranteed because the technology still has to pass the test of the 20 year timeframe. They are in real terms entrepreneurs and venture capitalists who took a risk..

However, these 'first movers' may also be willing to do so with batteries. There are two facts that relate: Energex will spend about \$1 billion on capex in the next year or two (if I remember correctly) and the government will pay out the 44 cent tariff to the 200K solar owners.

How about a "10 %" programme?

Energex offers 10% of these owners a battery system in exchange for ending their FIT, AND a real price for the energy they feed in at peak times. Energex (and Ergon) get to control the discharge at peak times and must use 10% of their capex for this programme.

Let's use me as an example: I receive about \$2000 a year from my FIT. Over the next 12 years, that's 24K. If the cost of the battery system AND the peak time FIT comes to about that, I may be willing to be a first mover.

This programme would only be offered in regions where Energex identifies such a feed in would avoid the need for network upgrades.

QLD thus leads the way for the intelligent use of battery systems that are controlled by the Network. The 20K systems would be tendered out in 5K concessions, and would need to be maintained under the watchful eye of the networks.

ENOPTe's box of magic can make this happen because it can both monitor and control not just the electricity, but the charging and discharging of the batteries, which is essential for warranty purposes.

I'm sure there are other ideas that can greatly expand the opportunities, but just looking at the costs, as it seems to what Energex is doing, will miss another chance to really make Qld shine.. pardon the pun.

best Sch4 CTPI

Subject: ^_Fwd^: ^_LNP^ ^_release^ - ^_Labor^ ^_must^ ^_come^ ^_clean^ on ^_energy^ ^_job^ ^_cuts^: ^_Powell^

From: Mark.Bailey@ministerial.qld.gov.au

To: mangocube6@yahoo.co.uk

Date: Thursday, 21 January 2016 10:06:11 AM AEST

Sent from my iPhone

Begin forwarded message:

From: Denise Spinks <Denise.Spinks@ministerial.qld.gov.au>

Date: 21 January 2016 at 9:53:22 AM AEST

To: Mark Bailey <Mark.Bailey@ministerial.qld.gov.au>, Tim Shipstone <Tim.Shipstone@ministerial.qld.gov.au>, Amy Hunter <Amy.Hunter@ministerial.qld.gov.au>

Subject: Fwd: LNP release - Labor must come clean on energy job cuts: Powell

Fyi

Will need QT prep on this one.

Tim/amy - pls modify hib to format to go to caucus today.

Thx

Sent from my iPhone

Begin forwarded message:

From: Wendy Bourne <Wendy.Bourne@ministerial.qld.gov.au>

Date: 21 January 2016 at 9:44:14 AM AEST

To: Denise Spinks <Denise.Spinks@ministerial.qld.gov.au>

Subject: LNP release - Labor must come clean on energy job cuts: Powell

. Labor must come clean on energy job cuts: Powell

Labor's Energy Minister Mark Bailey must address community concerns over potential job cuts at state-owned Ergon Energy, the LNP Opposition says.

Shadow Energy Minister Andrew Powell said Ergon workers yesterday walked off the job in Bundaberg, citing fears of job losses and a wind-back in network maintenance as major issues.

"This latest strike in Bundaberg follows a similar walkout in Atherton last week, where the same issues were raised," Mr Powell said.

“The Palaszczuk Labor Government must be held to the commitment they made to protect frontline workers.

“Minister Bailey had previously publicly guaranteed job security for workers at state-owned electricity companies but has now gone to ground.

“It’s concerning for workers and for the community that we’re hearing reports 13 Ergon jobs are to be cut from the Fraser-Burnett region alone, but Minister Bailey remains silent.

“Queensland has so much potential but this kind of sloppy administration from Labor is holding our state back.”

Mr Powell said the LNP was also concerned over reports of cuts to crucial maintenance programs at Ergon.

“The Palaszczuk Labor Government has loaded up Ergon with the state’s debt and is stripping all profits out of the company to fill their budget black hole,” he said.

“I’ve always feared that these short-sighted decisions could impact network safety and reliability in the future.

“The Energy Minister’s old union even describes the current situation at Ergon as ‘dangerous’ and ‘unsafe’.

“These are very serious claims and more than 733,000 Ergon customers and thousands of employees deserve an upfront response from Energy Minister Mark Bailey on this issue.”

[ENDS] 21 January 2016

Subject: California Regulators Approve Pilot EV Charging Program for Southern California Edison - Renewable Energy World

From:

To: mangocube6@yahoo.co.uk;

Date: Friday, 22 January 2016, 16:28

fyi..

<http://www.renewableenergyworld.com/articles/2016/01/california-regulators-approve-pilot-ev-charging-program-for-southern-california-edison.html>

California Regulators Approve Pilot EV Charging Program for Southern California Edison

The California Public Utilities Commission (CPUC) on Jan. 14 said it has authorized Southern California Edison (SCE) to develop a pilot program to incentivize the deployment of approximately 1,500 electric vehicle charging stations in the utility's service territory.

"This decision takes bold action in support of transportation electrification, while simultaneously preserving competition and exercising prudence on behalf of ratepayers," CPUC Commissioner Carla Peterman said in a statement.

SCE received authorization to spend \$22 million on implementation of the first phase of its Charge Ready and market education programs under a settlement agreement among parties that was modified and approved by the CPUC.

"A major barrier to electric vehicle ownership is that there aren't enough charging stations where people normally park their cars," Caroline Choi, SCE vice president for energy and environmental policy, said in a Jan. 14 statement. "We believe that by giving electric vehicle owners more options to charge their vehicles, this program can actually help to accelerate the market in Southern California."

According to Choi, SCE will install and maintain supporting electrical infrastructure in places where people park their cars for extended periods of time, such as workplaces, campuses, recreational areas and apartment complexes. The cost of the supporting infrastructure will be covered by the Charge Ready program, while participants will own, operate and maintain qualified charging stations.

As an incentive to participate in the program, SCE will offer rebates of between 25 percent and 100 percent of the base cost of the charging stations and their installation, depending on location and market segment. The program also calls for at least 10 percent of the charging stations to be installed in disadvantaged communities.

In its ruling, the CPUC said that "the rebate issue is critical." SCE, in a proposed settlement for its October 2014 application for the Charge Ready program, suggested rebates of 100 percent for multi-unit dwellings, but the CPUC found that a 100 percent rebate was not appropriate except in disadvantaged communities.

The CPUC approved a recommendation for a rebate of 25 percent for all market segments except disadvantaged communities, and a 50 percent rebate for multi-dwelling units in non-disadvantaged communities.

“With a consistent rebate, SCE will be able to evaluate whether and to what degree the rebate level improves the rate of installations across the different market segments,” the CPUC said.

For the second phase of the program, SCE said it will seek authority from the CPUC to bring the total number of charging stations to about 30,000 for a total estimated cost of \$355 million. The CPUC also approved funding for education and outreach to develop awareness about the benefits of electric vehicles and charging from the power grid.

“While electric vehicles currently cut carbon emissions by 70 percent, they will only get cleaner and cleaner because the grid is getting cleaner as the result of state clean air policies,” Choi said.

SCE said it expects to begin accepting applications from prospective participants in March.

Lead image: Sign pointing to an area for electric vehicle parking. Credit: Shutterstock.

Released under RTI Act - TMR

Subject: RE: Our Demands as Discussed
From: denise.spinks [Sch 4 CTPI] denise.spinks [Sch 4 CTPI]
To: mangocube6@yahoo.co.uk;
Date: Friday, 22 January 2016, 8:36

ok thanks

Different to what linda said -- should I call her back too??

From: mangocube6@yahoo.co.uk
Subject: Fwd: Our Demands as Discussed
Date: Fri, 22 Jan 2016 07:57:02 +1000
To: denise.spinks [Sch 4 CTPI]

FYI... Only just noticed this. Will still have the chat this morn. M

Sent from my iPhone

Begin forwarded message:

From: "Peter Simpson (ETU)" <simmo@etu.org.au>
Date: 21 January 2016 at 8:22:58 PM AEST
To: Mark Bailey <mangocube6@yahoo.co.uk>
Subject: Re: Our Demands as Discussed

A proper #E<{# non union EBA, went desk to desk standing over staff, then when you guys got in, put their hands up for the union deal, we objected, strongly for obvious reasons

[Sch 4 CTPI]

Don't know what piece of paper you need to be a CEO mate but there's some half decent ones in the other (not [Sch 4 CTPI] camp) next level down

Regards,

Peter Simpson
State Secretary
Electrical Trades Union
Queensland
M [Sch 4 CTPI] NR
F: (07) 3844 9851
simmo@etu.org.au
www.etu.org.au

Join Online
www.etuyes.com
Or call
1800ETUYES

Disclaimer

The information contained in the e-mail is intended only for the use of the person(s) to whom it is addressed and may be confidential or contain legally privileged information. If you are not the intended recipient you are notified that any perusal, use, distribution, copying or disclosure is strictly prohibited. If you have received this e-mail in error please immediately advise us by return e-mail and delete the e-mail document without making a copy.

On 21 Jan 2016, at 8:05 PM, Mark Bailey <mangocube6@yahoo.co.uk> wrote:

Roger that. M

On Thursday, 21 January 2016, 19:53, Peter Simpson (ETU) <simmo@etu.org.au> wrote:

Googled that chic, she was a }#^*%) during the EBA mate, knew I knew her name from somewhere

Regards,

about:blank

Peter Simpson
 State Secretary
 Electrical Trades Union
 Queensland
 M. NR
 F. (07) 3844 9851
 simmo@etu.org.au
 http://www.etu.org.au/

Join Online
<http://www.etuyes.com/>
 Or call
 1800ETUYES

Disclaimer

The information contained in the e-mail is intended only for the use of the person(s) to whom it is addressed and may be confidential or contain legally privileged information. If you are not the intended recipient you are notified that any perusal, use, distribution, copying or disclosure is strictly prohibited. If you have received this e-mail in error please immediately advise us by return e-mail and delete the e-mail document without making a copy.

On 21 Jan 2016, at 7:26 PM, Mark Bailey <mangocube6@yahoo.co.uk> wrote:

Good stuff! M

On Thursday, 21 January 2016, 15:23, Peter Simpson (ETU) <simmo@etu.org.au> wrote:

Sorted mate

Thanks eh

Sent from my iPhone

Begin forwarded message:

From: "JORDON Paul (WB)" <paul.jordon@ergon.com.au>
Date: 21 January 2016 at 2:37:49 PM AEST
To: Stuart Traill <stuart@etu.org.au>
Cc: "Peter Simpson (ETU)" <simmo@etu.org.au>
Subject: RE: Our Demands as Discussed

Thanks Stuart,

I shall touch base with you tomorrow to discuss any issues from the update Peter sent through on the broader list of actions. I shall also discuss the timing etc. of the resource discussions proposed below.

Regards,

Paul Jordon
 Acting Executive General Manager Customer Service
 Ergon Energy

From: Stuart Traill [mailto:stuart@etu.org.au]
Sent: Thursday, 21 January 2016 2:32 PM
To: JORDON Paul (WB)
Cc: Peter Simpson (ETU)
Subject: RE: Our Demands as Discussed

Jordo,

I can live with that.

Cheers,

Stuey.

From: JORDON Paul (WB) [mailto:paul.jordon@ergon.com.au]
Sent: Thursday, 21 January 2016 2:00 PM
To: Stuart Traill
Subject: RE: Our Demands as Discussed

Stuart,

As discussed, I propose the following measures to address the issues you have raised and so as we can consult around resourcing and the forward works program.

A meeting is held in Brisbane with yourself, relevant senior ETU delegates and Ergon Energy representatives to consult on, review and take feedback on the AER outcomes, the forward works

program and proposed strategies regarding internal and external resource levels at Hub level and at a rolled up view. This would also subsequently be tabled at SBU.

With regard to the proposal to review asset inspection cycle times, it is acknowledged that appropriate Union input and consultation is necessary prior to considering such an initiative. As such, this issue would not be tabled for consultation earlier than the 1st of March at which point the appropriate consultative processes would be employed.

I can confirm that items 2, 3 and 4 in your email are not current proposals for implementation and that further communication and consultation with Unions is required regarding the resourcing strategy. Issues such as the AER impacts on the works program, internal resource levels and the nature and quantity of external resources to be utilised to deliver the works program would form part of those consultative processes.

Once we have ETU agreement to the above issues, I shall provide a communication to Ergon Energy employees outlining these issues and approach to be taken.

I appreciate the time you have taken to address these issues and am happy to further discuss the proposals above if necessary.

Regards,

Paul Jordon
Acting Executive General Manager Customer Service
Ergon Energy

From: Stuart Traill [mailto:stuart@etu.org.au]
Sent: Wednesday, 20 January 2016 11:26 AM
To: JORDON Paul (WB)
Cc: COLEMAN Troy (NQ); DOWD Daniel (NQ); Peter Simpson (ETU); Michael Haire; Wal; daniel; BLOOM Greg (NQ); CONWAY Jason (CA); McGAW Chris (SW); HILL Robert (FN); RIX Ian (MK); SOLOGINKIN Scott (WB)
Subject: Our Demands as Discussed

Jordo,

Our Position is that our Senior Delegates remain committed and available to meet with Hub Managers to discuss local works plans and associated resourcing on the basis that the Managers are genuine in their discussions. We are sick of having meetings only to be ignored by Managers hiding behind the AER argument with no substantiating facts.

At a broader Ergon level I am reluctant to talk to Ergon based on Ergon's refusal to comply with it's consultation obligations in the UCA unless,

1. Ergon withdraws its current proposal to increase inspection cycles out to 6 years, this is an Industry wide issue and should be dealt with on an Industry wide basis.
2. Ergon withdraws its proposal to cut 14 jobs in Tropical North and 13 jobs in Fraser Burnett.
3. Ergon withdraws its current proposal to outsource an additional 45000 hrs of work to Contract for the 15/16 year that could be done internally.
4. Ergon withdraws its current proposal to outsource the Street Light Maintenance work that could be done internally.

The above will demonstrate that Ergon is serious about its obligations to provide frontline resources and committed to its obligations to genuinely consult with our Union.

Please advise,

Stuart Traill
Supply Industry Coordinator
Electrical Trades Union
Queensland
M. NR
F. (07) 40513502
stuart@etu.org.au
www.etu.org.au



Desc:
Join Online
www.etuyes.com
Or call
1800ETUYES



Description:

cid:5330643B-9807-47A3-963C-3EFAE2821AA1

<http://www.not4sale.org.au/>

To report this email as spam, please forward to asa@websense.com

This e-mail (including any attachments) may contain confidential or privileged information and is inten-

Ergon Energy Corporation Limited ABN 50 087 646 062

To report this email as spam, please forward to asa@websense.com

This e-mail (including any attachments) may contain confidential or privileged information and is inten-

Ergon Energy Corporation Limited ABN 50 087 646 062

Released under RTI Act - TMR

Subject: California keeps retail rate for rooftop solar, adds time-of-use : Renew Economy

From: Sch 4 CTPI

To: mangocube6@yahoo.co.uk;

Date: Friday, 29 January 2016, 14:13

<http://reneweconomy.com.au/2016/californias-nem-2-0-decision-keeps-retail-rate-for-rooftop-solar-adds-time-of-use-99287>

California keeps retail rate for rooftop solar, adds time-of-use



California's next four years of net metering policy have fallen into place, and for the solar industry, it's a major victory — with a big dose of uncertainty, and a considerable amount of last-minute conflict.

On Thursday, the California Public Utilities Commission voted 3-to-2 to enact its net energy metering (NEM) successor tariff, also known as NEM 2.0. For the past decade, this policy has assured net-metered customers that they'll earn retail-rate payments for their surplus solar energy, which has helped push the state to lead the country in rooftop solar deployments.

As expected, Thursday's decision upholds those retail rates, handing solar companies an important win, compared to recent net-metering losses in states like Hawaii and Nevada. Much of the public battle between solar advocates and California's big investor-owned utilities has been about these rates — utilities had asked to cut them, saying they unfairly shifted costs to non-solar customers.

But the new regime also imposes an "aggressive" move to time-of-use rates for net-metered customers, Commission President Michael Picker noted. Starting as soon as the successor tariff is implemented, net-metered solar customers will be required to move to TOU rates that charge different prices during different times of the day, to better match real-time costs of generating and transmitting energy across the grid at large.

Solar groups have given tentative support to this concept, but have worried that its implementation, still being worked out in CPUC proceedings and upcoming pilot projects, might make it difficult to predict the economics of net-metered solar systems in years to come. "We support a movement towards time-of-use rates, as better aligning grid needs with economic signals," Adam Browning, executive director of the Vote

Solar advocacy group, said after Thursday's vote, but added, "we would have preferred to see a more gradual phase-in."

The 124-page decision, which included some changes posted only a day before Thursday's vote, also reduced some of the "non-bypassable" charges that new net-metered customers will be required to pay. Specifically, they won't pay transmission charges as part of that mix. That will reduce the average non-bypassable costs of a typical residential rooftop solar system from about 4 to 5 cents to about 2 to 3 cents per kilowatt-hour, Browning said.

But Commissioners Catherine Sandoval and Mike Florio, who voted no, said it was this last-minute exclusion of transmission charges that forced their decisions. Both said it was going too far in a decision that already favors solar compensation over fairly sharing grid and energy costs across all classes of utility customers.

"If anything, it would have made sense to me to reduce the solar compensation to reflect and share the benefit of the Investment Tax Credit extension," Florio said in Thursday's meeting. "But these last changes have taken a decision already hailed by the solar industry, and made it even richer. And I don't think these benefits are going to accrue to solar customers — they're going to accrue to solar vendors."

But Commissioners Liane Randolph and Carla Peterman joined Commission President Michael Picker in voting yes for the decision and putting it into effect. Each noted that the decision wasn't perfect. They also highlighted that Thursday's decision sets a 2019 deadline to reconsider its net metering policies and to adjust their value equations in light of other regulatory proceedings underway in the state.

"This has been a very contentious, very complicated process," Picker said. But "it's a big step toward giving California consumers more choice, more responsibility, and more control over their energy usage."

Source: Greentech Media. Reproduced with permission.

Attachments

- [california-flag_410_282_c1.jpg \(76.95 KB\)](#)

Subject: Proserpine Faust Dam

From: Sch 4 CTPI

To: mangocube6@yahoo.co.uk;

Date: Friday, 29 January 2016, 13:37

Hi Mark

As briefly discussed, the talk of the town in Proserpine is how do we attract visitors to the area without them bypassing and heading north or to Airlie Beach?

The local Council have been pretty quiet when it comes to Proserpine for the last 4 years with attention obviously going to the Whitsunday Coast Airport, Airlie Beach and Whitsunday Islands. (And rightly so) There has been chatter amongst a couple of Councillors about setting up an RV stop for grey nomads – discussions have been with the Proserpine Chamber of Commerce – it looks like it's been all too hard so there hasn't been any update. The local Council are busy with chinese investors, renovating brick walls at Airlie Beach while the town of Proserpine is pretty much being ignored.

Peter Faust Dam, which is around 23 kms from Proserpine is known to locals and visitors for its barra fishing. It's also the place where you take family/friends when they visit the region. Currently, there are toilet facilities/BBQ/great boat ramp – just the necessary things you'd find at a 'middle of nowhere' location. To get to the dam, you need to drive through the main street of Proserpine, small businesses, pubs, etc.

There's also Camp Kanga which is located right next to the dam, however, is not a very attractive place to stay for school excursions, Scouts events, etc. (It's rundown and I think it's leased or owned by the Lions)

What this dam does not have is camping facilities, in fact I don't think you're permitted to camp there. I've attached an article from when Kate Jones visited the region late last year in which got the town talking about a potential boost to the local economy, if anyone actually investigated this idea.

Tracey Cameron (pictured) would like to look into this further however is not sure where to start. I know that surrounding dams like Kinchant Dam have these facilities – even locals travel there because there's no facilities at the Faust Dam

So the questions are...

- Who owns the land around the Peter Faust Dam
- What involvement does Sunwater have
- What's Council's involvement
- Who is responsible for making decision on camping sites and who would look after the area

- Is there potential for this to be an election commitment/campaign

I've also attached a bit of info from Tracey Cameron.

<http://www.dailymercury.com.au/news/luring-tourists-to-town/2783769/>

Thanks!!

Sch 4 CTPI

Attachments

- Camping.docx (11.44 KB)

Released under RTI Act - TMR

Camping & RV facilities at Lake Proserpine/Peter Faust Dam

The benefits of having a camping facility located at Peter Faust Dam are considerable, as well as being something that the local Proserpine community is very much in favour of.

A permanent eco friendly campground/RV park at the dam is an opportunity to boost the economy of many local businesses in our area and promote our region.

Many 'grey nomads' have expressed an interest in staying in the Proserpine area for extended periods, preferring a quiet bush setting in favour of the Airlie Beach party atmosphere.

As a result of no facilities at the dam, many travellers bypass Proserpine and head north to Home Hill, Ayr etc. Camping/RV facilities at Peter Faust Dam will encourage many to stay for awhile & explore our region.

The close proximity to town is a point raised by many, as a positive thing, the other dams in the Whitsunday region, have camping facilities but are located further from town.

With Peter Faust Dam being a popular destination for fishermen (it's well stocked with large barramundi & many other fresh water species), water skiing, kayaking, family barbecues and picnics etc, both locals and travellers are eager to utilise the dam for more recreational activities while being able to stay overnight and for weekends.

As the dam is only accessible by driving through the township of Proserpine, it is a wonderful opportunity to bring with it, a welcome boost for many of the struggling businesses in our town.

Aside from assisting the local economy, it's a great way of introducing many to the wonderful experiences and sights available in our region.

We have a many fantastic things to offer travellers - Proserpine Museum, Colour Me Crazy, Retro Skate (roller skating rink) The Whitsunday Coffee Farm, Cedar Creek Falls, Conway Beach, Wilson Beach, Midge Point, Hydeaway Bay, Dingo Beach, Bowen Cinema and much more – all of these are in close driving distance from Proserpine.

Subject: Fwd: Getup petition error - Abbot Point-

From: [Sch 4 CTPI]

To: mangocube6@yahoo.co.uk;

Date: Sunday, 31 January 2016, 21:58

And then there was [Sch 4 CTPI] Bless her cotton socks. She did this before I got active.

Sent from my iPad

Begin forwarded message:

From: [Sch 4 CTPI]
Date: 31 January 2016 at 1:34:49 PM AEST
To: [Sch 4 CTPI]
Subject: Re: Getup petition error - Abbot Point-

I wrote to Get Up on 28th,

Hi Get Up, Ironically yesterday - a day when I was questioning the Get Up report about Abbot Point Labor promises and Adani, I received my Get Up t-shirt in the mail. I hope Get Up will report back to all the thousands of people who respect Get Up and rely on your attention to issues which matter, of whom I am one.

no reply yet.

I'll try again in a few days. [Sch 4 CTPI]

Expect Get Up send out an apology.

Give their huge effort the odd error is understandable. Nevertheless a correction must be made when an error occurs.

On 31 Jan 2016, at 12:51 pm, [Sch 4 CTPI] wrote:

If you are inclined to ask Getup about their Abbot Pt and Adani petition, their email is: info@getup.org.au

[Sch 4 CTPI]

Sent from my iPad

Begin forwarded message:

From: [Sch 4 CTPI]
Date: 31 January 2016 at 9:36:15 AM AEST
To: [Sch 4 CTPI]
Subject: Getup petition- Abbot Point

Below see an extract from the Facebook page of Minister Bailey who has responsibility for Ports.

Getup put out a petition saying the Qld Govt had broken an election commitment not to put State money into the Adani project.

This is absolutely untrue and Getup knows it but has done nothing to correct the matter.

Meanwhile it has gone viral and I have had many emails/texts condemning the Labor Govt.

The Queensland Govt has in fact allocated \$4.2million to the upgrade of the general port facility at Abbot Point. This has nothing to do with the Adani project.

If you have signed the petition, I urge you to contact Getup and ask that your signature be removed as you were misled.

Apart from the petition being factually incorrect, surely Getup would know that \$4.2million would have absolutely no impact on any decision Adani might make in relation to their proposed \$multi billion project. The suggestion is absolutely ridiculous.

Getup should protect their reputation and correct the record.

.....
The Palaszczuk Government has not committed any funding to financially assist Adani.

What is actually happening is the material offloading facility (MOF) at Abbot Point is being upgraded by North Queensland Bulk Ports (NQB) to improve safety of the port and to facilitate handling of new products coming into the port. .

This is a common user facility that is located on NQB land and is separate to the Adani terminal.

This is a necessary piece of port infrastructure and the upgrade is required regardless of whether the Adani project is developed or not.

This safety upgrade includes replacing sheet piling and is aimed at attracting new customers.

The upgraded MOF will be operated by NQB – with costs to be recovered from current port users.

It is not part of the long trestle wharf used to export resources.

Any suggestion that funding the MOF breaks our Government’s election commitment is factually inaccurate.

Sent from my iPhone

Subject: Fwd: Petition re Qld Govt- broken promise Adani

From: Sch 4 CTPI

To: mangocube6@yahoo.co.uk;

Date: Sunday, 31 January 2016, 22:08

And then this old bugger had a go.

Sent from my iPad

Begin forwarded message:

From: Sch 4 CTPI
Date: 31 January 2016 at 1:16:09 PM AEST
To: info@getup.org.au
Subject: Petition re Qld Govt- broken promise Adani

Greetings,

There has been widespread condemnation of the Queensland Government in circles I mix in arising from a Getup petition saying that they had broken an election commitment not to put public money into supporting the Adani project.

You sited funds allocated to the Abbot Point port facility as a contribution to assist Adani. I have now done my home work and find the broken promise allegation to be totally false.

The funds allocated are for upgrades to the general use facility operated by Queensland Bulk Ports. This a completely separate from the Adani terminal.

I hope you will come back to me about this matter. I also hope you will correct the allegation in the public arena. It was a damaging allegation coming from Getup, who are widely respected, at least in my circle of friends.

Sch 4 CTPI

Sent from my iPad

Released Under RT Act - TMR

Subject: Your Facebook Adverts Receipt (Account ID: 22596962)
From: Facebook Ads Team (advertise-noreply@support.facebook.com)
To: mangocube6@yahoo.co.uk;
Date: Sunday, 31 January 2016, 22:48



Receipt for Mark Bailey (Account ID: 22596962)

Your billing threshold is currently \$60.00. Learn more about your billing threshold and how billing works.

Summary

AMOUNT BILLED \$36.68 AUD MasterCard *8190	PRODUCT TYPE Facebook Adverts	FROM 22 January 2016 05:00	TO 30 January 2016 04:59
--	---	--	--

CAMPAIGN	RESULTS	AMOUNT
Post: "At the Port of Townsville with Premier Annastacia..."	3,886 Impressions	\$15.13
Post: "The first Tesla Powerwall has arrived and its at..."	2,716 Impressions	\$11.87
Post: "Today I joined Steven Miles MP to announce the..."	1,278 Impressions	\$9.68
TOTAL		\$36.68

Transaction ID: 814931905285091-1729514

Thanks,
The Facebook Adverts Team

[Manage Your Adverts](#)

[See Full Receipt](#)

This is an automated message. Please do not reply. If you have questions about adverts, you can get help. You can also manage your email notification settings for this advert account.

Facebook, Inc., Attention: Community Support, Menlo Park, CA 94025

Subject: Fwd: Major Emerging Ergon Issue
 From: Peter Simpson (ETU) (simmo@etu.org.au)
 To: mangocube6@yahoo.ca.uk; Sch4 CTPI
 Date: Tuesday, 12 January 2016, 20:34

Comrades,

Just a heads up, this (below from Stuey) is going to blow up within Ergon, Stuey is talking to Shankey, but a heads up for you guys.

Also, ENERGEX and Ergon are telling us they are talking to the Govt reps about the amalgamation process and meetings, we are supposed to meet the working group on the 15th but we've heard nothing, if that's the way DIR want to play this, we will not be getting this done within the timeframe that's been set, not a promising start to the year.

Further, I spoke to Mark Algie today, the consultant I've been talking to you about. Imogen spoke to him before she left but now she's gone I don't know who to progress it with.

Know you're off Curtis but we are heading into shitfight territory already and it's only the twelfth day of the New Year. FYI.

Simmo

Regards,

Peter Simpson
 State Secretary
 Electrical Trades Union
 Queensland
 M. NR
 F. (07) 3844 9851
simmo@etu.org.au
www.etu.org.au

Join Online
www.etuyes.com
 Or call
 1800ETUYES

Disclaimer

The information contained in the e-mail is intended only for the use of the person(s) to whom it is addressed and may be confidential or contain legally privileged information. If you are not the intended recipient you are notified that any perusal, use, distribution, copying or disclosure is strictly prohibited. If you have received this e-mail in error please immediately advise us by return e-mail and delete the e-mail document without making a copy.

Begin forwarded message:

From: Stuart Traill <stuart@etu.org.au>
 Date: 12 January 2016 at 3:27:31 PM AEST
 To: "Peter Simpson (ETU)" <simmo@etu.org.au>
 Subject: Major Emerging Ergon Issue

Simmo,

I just hung up on Ergon Management after they have today advised that they will come to us next month with a reduction in the works programme.

They have also advised us that they intend to extend the current inspection cycles which will significantly expose the risk of outages and significant safety issues due to asset failures.

They have also advised us that they will present to us the current field based vacancies that they intend to close out and not backfill.

We have good apprentices getting told they aren't needed upon completion.

They have also advised us they intend to reduce field based staff numbers in Far North by 14 on top of the unfilled vacancies and a further 13 in the Frazer Burnett region due to the alleged reduction in the works programme.

They then proposed a plan to outsource streetlight maintenance that could be done internally and worse still an extra 45 000 hrs of work out to contract on the basis that Ergon doesn't have the internal resources, of course they won't have the resources to do the work.

We had the storm through the SW on Chrissy day and needed to bring in Contractors and Energex due to not having enough staff to adequately respond.

I am in the process of pulling together a State wide tour to blow this up, Ergon management are pulling this shit on prior to the merger and I refuse to allow them to destroy all the good work that was done through the Sommerville enquiry without one hell of a blow.

Our members will explode when we give them an update, so much for Ergon complying with the Govt's regional employment policies.

Will keep you updated.

Cheers,

Stuart Trull

Supply Industry Coordinator

Electrical Trades Union

Queensland

M NR

F: (07) 40513502

stuart@etu.org.au

www.etu.org.au



Join Online

www.etuyes.com

Or call

1800ETUYES

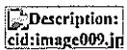

cid:5330643B-9807-47A3-963C-3EFAE2821AA1

www.not4sale.org.au

Attachments

- image001.png (5.07 KB)
- image002.jpg (1.48 KB)
- image003.jpg (1.08 KB)
- image004.png (154.71 KB)

Subject: FW: Merger
From: Peter Simpson (ETU) (simmo@etu.org.au)
To: mangocube6@yahoo.co.uk Sch 4 CTPI
Date: Thursday, 14 January 2016, 8:19

Well we're off to a flying start Comrades, game on

From: Peter Simpson (ETU)
Sent: Thursday, 14 January 2016 8:17 AM
To: Stuart Traill <stuart@etu.org.au>
Subject: Merger

Mate,

Got a call from John Fraser (Treasury) last night telling me that ENERGEX and Ergon would be putting out comms today in relation to committees they have set up. He said he'd send me a draft last night, no sign of it this morning.

I gave him a rev as you'd expect, same shit, different restructure. When I asked him who the Union representatives on these committees were, he near choked, short answer there are none! Can you get the Senior's to keep an eye out this morning and flick me any comms that come out and get them ready for a shitfight, they are only talking to the businesses, not us, I'll take that up with Govt (again)

Simmo

Regards,

Peter Simpson
 State Secretary

NR

simmo@etu.org.au

Released under RTI Act - TMR

Released under RTI Act - TMR

Subject: FW: Network Merger Communications

From: Peter Simpson (ETU) (simmo@etu.org.au)

To: Sch 4 CTPI mangocube6@yahoo.co.uk;

Cc: Sch 4 CTPI stuart@etu.org.au;

Date: Thursday, 14 January 2016, 9:25

Comrades,

Just got this and it highlights exactly what I raised the first meeting we had on this Mark, in the IR space, they have the most incompetent, evil, useless piece of shit in Industrial Relations, ENERGEX's Ian Hess, down as one of the leads on this committee.

You'd remember the paper I handed to you when we first met in your new office early that morning in February, I flagged this exact concern and asked for an external consultant by the name of Mark Algie, Ex Ergon Energy, to be involved in this space to save us all a lot of grief.

I've had subsequent discussions with Curtis and Imogen to that end and I understand from Mark Algie that he met with Imogen just before Xmas.

For this to be released without any further discussion, is just a poke in the eye to us. I'll talk to the others but if this is the road we're going down we will not play any part in it.

Curtis, again, ask Dionne about this Hess character, I wouldn't employ him to weed my garden, I can't speak lowly enough about the man or his style of IR. He loved his job under Newman, that might give you a hint.

Yours in absolute frustration!

Simmo

From: John Frazer [mailto:JFrazer@qtc.com.au]
Sent: Thursday, 14 January 2016 8:48 AM
To: Peter Simpson (ETU) <simmo@etu.org.au>; Neil Henderson <Neil.Henderson@theservicesunion.com.au>; rohan.webb@amwu.asn.au; AKerslake@professionalsaustralia.org.au

Cc: kscott@professionalsaustralia.or.au
Subject: Network Merger Communications

Peter, Neil, Rohan and Adam

As per my email last night and telephone conversations, please find attached communications to all staff of Ergon, Energex and SPARQ.

As you can see this comms is only an update and relates mostly to the establishment of workstreams and the transfer of various personnel from the businesses to the project team. You will also note that there is a reference to the establishment of an Industrial Relation Group

The businesses will be releasing these communications to all staff at 10am so I would appreciate if you could embargo any release from your unions until this time.

Please call me if you have any questions.

Regards

John

John Frazer

Executive General Manager | Risk Analysis Division

Queensland Treasury Corporation

GPO Box 1096 Brisbane Queensland Australia 4001 | Level 6 123 Albert St Brisbane Queensland 4000

T +61 (0)7 3842 4856 | M NR | jfrazer@qtc.com.au | www.qtc.com.au



COMMERCIAL-IN-CONFIDENCE - FOR THE PURPOSE OF PREPARATION OF A REPORT TO CABINET

IMPORTANT: This email transmission including any attachments to it is confidential. It may contain information that is subject to privilege or privacy obligations, or being utilised for preparation of a report to the Queensland Government Cabinet or which is protected by copyright or other intellectual property rights.

If you are not the intended recipient of this email transmission, any use, interference with, disclosure or copying of this email transmission or action taken in reliance on this email transmission is unauthorised, prohibited and may be unlawful. Please notify us if you have received this email transmission in error and delete the email.

If you are the intended recipient, you must ensure that this email transmission and the information it contains is treated so as to maintain confidentiality and privilege, and ensure that privacy obligations are observed. No copy, summary or reference to any advice or information contained in this email transmission is to be included in another document or provided outside of Queensland Treasury Corporation without the prior consent of the Project Director, Electricity Mergers Project Team.

This email including attachments is intended only for the addressee and may be confidential and privileged. If you are not the addressee, you must not copy or use this email for any purpose, nor disclose its contents to anyone, please delete it and notify the sender by return email. | Any opinion or advice provided in this message is subject to any assumptions noted within it and the assumption that the current economic, political and/or commercial environment does not materially alter. QTC does not warrant or guarantee any outcome or forecast in this message. Any opinion or advice in this message is provided by QTC in good faith on the basis of information supplied to QTC. QTC has not independently verified the information supplied to it, and accordingly does not represent that the information provided to QTC is accurate or complete and it should not be relied upon as such. | To the extent permitted by law, neither QTC nor any of its employees, contractors, servants or agents accept any responsibility and liability whatsoever for any expense, damage, claim, cause of action, loss or costs, incurred by any person in connection with that person or any other person placing any reliance on, or acting or refraining to act on the basis of, the contents of this email. | QTC respects your privacy, and our privacy plan is available on our website.

Attachments

- 221060-14 160113 Workstream team announcement Fact Sheet - FINALv1.pdf (101.49 KB)
- image001.jpg (3.56 KB)

Released under RTI Act - TMR

Announcement of electricity merger workstream teams



As part of the Queensland Government's plan to merge the State's power distribution businesses, Energex and Ergon Energy, we are pleased to announce the names of new Merger Integration Project team members. The early stages of the merger planning have been completed and 19 employees of Ergon Energy, Energex and Sparq will join the Merger Integration Project team for the next stage.

The appointment of workstream leaders and teams represents a significant milestone for the project. The Merger Integration Project team will be responsible for establishing the merged business as an efficient, adaptable energy company with a strong focus on customers, local communities and delivering sustainable price outcomes.

Workstream leaders and team members have been drawn from across Ergon Energy, Energex and Sparq, and will work collaboratively within the Merger Integration Project team. The merged parent company will be established by mid-2016.

Workstream leaders and team members will be seconded to the Merger Integration Project and will work with the Integration Leader, **Scott Turner**, to plan for the merger of the businesses. Some team members have been seconded to the merger team on a full-time basis, while others will participate part-time.

Other staff within Ergon Energy, Energex and Sparq will also have important roles to play in the merger process by covering the roles of team members seconded to workstreams, providing input to the project teams, and ensuring the businesses continue to operate to high standards of safety, reliability and customer

service. As the merger process progresses, other team members may also be seconded into the Merger Integration Project team.

This stage of the merger process will also involve the establishment of the Electricity Business Restructure Industrial Relations Consultation Group. This will be an important forum for engaging and consulting with unions over the course of the merger process, and for the group to provide advice and oversight on industrial relations issues.

Workstream leaders and team members will work within seven key workstreams during this stage of the Merger Integration Project.

The **Future Operating Model** workstream will develop the high-level organisational structure and functions for the merged business.

The **Operational Transformation** workstream will consider current operational processes and work practices and how these will function in the merged business.

The **Energy Services** workstream will consider the business model for the new energy services business.

Staff in the remaining four workstreams will work with the Merger Integration Project team on a part-time basis to support aspects of the merger. The **Merger Synergies** workstream will capture business data and track efficiency savings from the merged group, while the **Communications, People Management and Industrial Relations, and Accounting, Tax, Legal and Regulatory** streams will support the process in their respective areas of expertise.

From 18 January, the following team members will be seconded to the Merger Integration Project team:

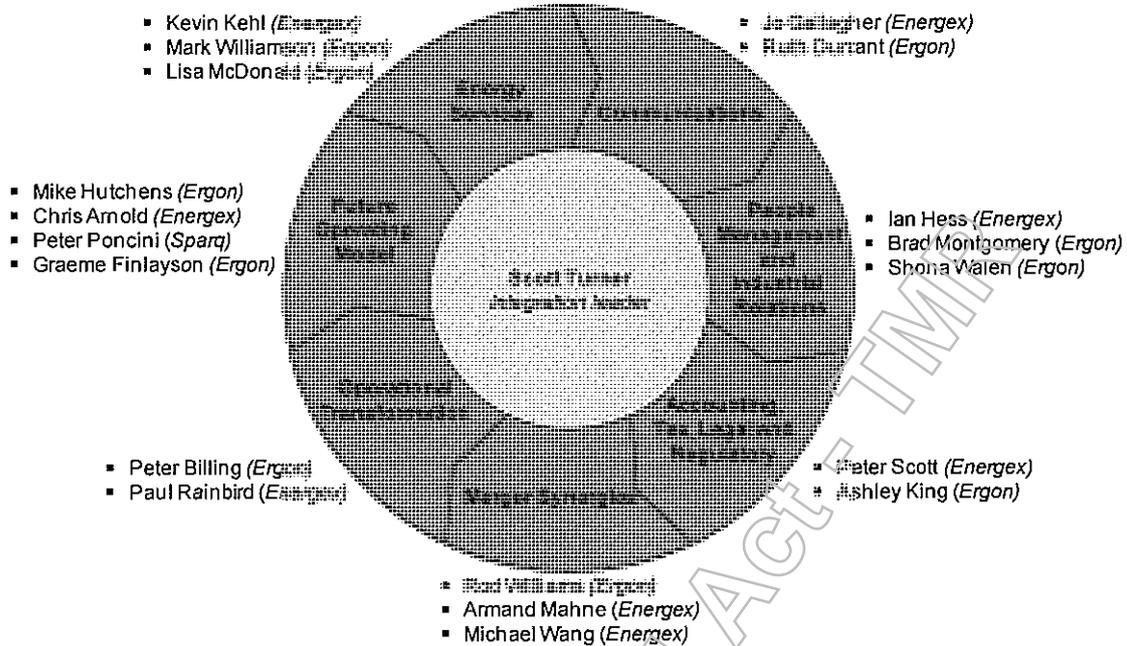

Of these seven workstreams, three will have full-time workstream leaders:

returns and achieving sustainable price outcomes for consumers."



Scott Turner will be the Integration Leader for the Merger Integration Project, responsible for providing leadership and support to the company workstreams and workstream leaders. In addition, Scott will lead the Future Operating Model workstream, responsible for developing the high-level organisational structure and functions for the merged business.



Kevin Kehl will lead the Energy Services workstream, responsible for the design of the new energy services business within the merged group.

Scott's most recent role was as the Acting Chief Financial Officer at CS Energy. Prior to this, he was the Executive General Manager of Energy Markets at CS Energy. Scott has previously held senior roles at Alinta Energy and Energex, including working as part of the Energex Retail sale process, and on the Service Essentials joint venture between Energex and Ergon Energy.

Kevin is the Executive General Manager for Strategy, Regulation and Governance at Energex. He has been an Executive General Manager since 2009. In addition to his current portfolios, he's also had previous responsibility for Finance and Customer / Corporate Relations.



Peter Billing will lead the Operational Transformation workstream, responsible for reviewing operational processes and work practices.

Following his appointment, Scott said *"For me, the project represents a unique opportunity to establish the merged business as a customer-oriented, efficient energy company that meets objectives such as supporting local communities, providing long term sustainable*

Peter is the Executive General Manager, Customer Service with Ergon Energy. He is responsible for the operational effectiveness of the distribution business and for the safe, efficient operation and maintenance of the network.

Subject: Re: Network Merger Communications
From: Peter Simpson (ETU) (simmo@etu.org.au)
To: mangocube6@yahoo.co.uk;
Date: Thursday, 14 January 2016, 10:26

Cheers mate, always the same with QTC, has been for the last 18 years I've been dealing with them

Sent from my iPhone

On 14 Jan 2016, at 10:24 AM, Mark Bailey <mangocube6@yahoo.co.uk> wrote:

Working it

Sent from my iPhone

On 14 Jan 2016, at 9:49 AM, Peter Simpson (ETU) <simmo@etu.org.au> wrote:

From: Peter Simpson (ETU)
Sent: Thursday, 14 January 2016 9:46 AM
To: 'John Frazer' <JFrazer@qtc.com.au>; Neil Henderson <Neil.Henderson@theservicesunion.com.au>; rohan.webb@amwu.asn.au; AKerslake@professionalsaustralia.org.au
Cc: Stuart Traill <stuart@etu.org.au>
Subject: RE: Network Merger Communications

John,

I've just read through this and we want to highlight our disgust that this has been tabled before the framework etc we had been working on before Christmas and indeed over the break, has been finalised.

My first reaction is to tell QTC to stick all consultation where the sun doesn't shine and ramp up an industrial campaign I'll be honest. I naively thought that QTC may have had a more consultative view of the world in the wake of Newman's demise, I was obviously wrong.

I'll talk to the others and let Govt know our collective position

Simmo

From: John Frazer [<mailto:JFrazer@qtc.com.au>]
Sent: Thursday, 14 January 2016 8:48 AM
To: Peter Simpson (ETU) <simmo@etu.org.au>; Neil Henderson <Neil.Henderson@theservicesunion.com.au>; rohan.webb@amwu.asn.au;
AKerslake@professionalsaustralia.org.au
Cc: kscott@professionalsaustralia.or.au
Subject: Network Merger Communications

Peter, Neil, Rohan and Adam

As per my email last night and telephone conversations, please find attached communications to all staff of Ergon, Energex and SPARQ.

As you can see this comms is only an update and relates mostly to the establishment of workstreams and the transfer of various personnel from the businesses to the project team. You will also note that there is a reference to the establishment of an Industrial Relation Group

The businesses will be releasing these communications to all staff at 10am so I would appreciate if you could embargo any release from your unions until this time.

Please call me if you have any questions.

Regards

John

John Frazer

Executive General Manager | Risk Analysis Division

Queensland Treasury Corporation

GPO Box 1096 Brisbane Queensland Australia 4001 | Level 6 123 Albert St Brisbane Queensland 4000

<T +61 (0)7 3342 4856 | M + NR | jfrazer@qtc.com.au | www.qtc.com.au

COMMERCIAL-IN-CONFIDENCE - FOR THE PURPOSE OF PREPARATION OF A REPORT TO CABINET

IMPORTANT: This email transmission including any attachments to it is confidential. It may contain information that is subject to privilege or privacy obligations, or being utilised for preparation of a report to the Queensland Government Cabinet or which is protected by copyright or other intellectual property rights.

If you are not the intended recipient of this email transmission, any use, interference with, disclosure or copying of this email transmission or action taken in reliance on this email transmission is unauthorised, prohibited and may be unlawful. Please notify us if you have received this email transmission in error and delete the email.

If you are the intended recipient, you must ensure that this email transmission and the information it contains is treated so as to maintain confidentiality and privilege, and ensure that privacy obligations are observed. No copy, summary or reference to any advice or information contained in this email transmission is to be included in another document or provided outside of Queensland Treasury Corporation without the prior consent of the Project Director, Electricity Mergers Project Team.

This email including attachments is intended only for the addressee and may be confidential and privileged. If you are not the addressee, you must not copy or use this email for any purpose, nor disclose its contents to anyone, please delete it and notify the sender by return email. | Any opinion or advice provided in this message is subject to any assumptions noted within it and the assumption that the current economic, political and/or commercial environment does not materially alter. QTC does not warrant or guarantee any outcome or forecast in this message. Any opinion or advice in this message is provided by QTC in good faith on the basis of information supplied to QTC. QTC has not independently verified the information supplied to it, and accordingly does not represent that the information provided to QTC is accurate or complete and it should not be relied upon as such. | To the extent permitted by law, neither QTC nor any of its employees, contractors, servants or agents accept any responsibility and liability whatsoever for any expense, damage, claim, cause of action, loss or costs, incurred by any person in connection with that person or any other person placing any reliance on, or acting or refraining to act on the basis of, the contents of this email. | QTC respects your privacy, and our privacy plan is available on our website.

Released under RTI Act - TMR

Subject: RE: ^_Escalating^_ ^_Ergon^_ ^_Issue^_

From: denise.spinks [Sch 4 CTPI]

To: mangocube6@yahoo.co.uk

Date: Wednesday, 20 January 2016, 1:08:26 pm AEST

fyi - I am now back online [Sch 4 CTPI]
ds

Date: Tue, 19 Jan 2016 05:30:59 +0000

From: mangocube6@yahoo.co.uk

To: denise.spinks@ [Sch 4 CTPI]

Subject: Fw: Escalating Ergon Issue

On Tuesday, 19 January 2016, 12:42, Peter Simpson (ETU) <simmo@etu.org.au> wrote:

Fyi

From: Peter Simpson (ETU)

Sent: Tuesday, 19 January 2016 12:42 PM

To: 'premier.palaszczuk@ministerial.qld.gov.au'
<premier.palaszczuk@ministerial.qld.gov.au>

Subject: FW: Escalating Ergon Issue

Importance: High

Premier,

Our members have asked me to send you correspondence directly in relation to the cutting of front line jobs within Ergon Energy. As you'd appreciate, I don't write to you very often and won't unless I'm passing on concerns on behalf of our membership, that is, after all, my job. I'll also make it my practice of raising such issues where I believe there is an potential industrial issue developing, such as this case.

As you may be aware our members at Atherton walked off the job over this issue last week and a meeting between Ergon management and the ETU yesterday was a wasted exercise in attempting to resolve it.

In light of the issues developing in Townsville and surrounds, this issue is also crucial, as we have many unfilled front line jobs that Ergon are now attempting to close out, to the detriment of local regional communities, particularly in the North and Bundaberg areas. Our members are growing increasingly frustrated by Ergon managements attempts to downgrade their community obligations in this regard.

I have been working closely with the Minister on this issue and appreciate you have bigger issues to deal with but I think it's important you're aware of it and our members are demanding we raise it with you, hence the email.

A summary of yesterdays' discussions below, for your info.

Simmo

From: Stuart Traill
Sent: Tuesday, 19 January 2016 12:30 PM
To: Peter Simpson (ETU) <simmo@etu.org.au>
Subject: Escalating Ergon Issue

Comrade,

Here is an update on Ergon.

Following the farcical proposal by Ergon to close out up to 80 existing vacancies, their refusal to give graduating apprentices jobs, their proposal to extend asset inspection cycles out to 6 years which will create serious safety issues due to failing assets, their proposal to slash NQ jobs by 14 and Fraser Burnett jobs by 13 and then their proposal to outsource 45 000 hrs of work and all Street Light maintenance on the basis that we don't have the internal resources we yesterday met with Peter Billing and Belinda Watton.

Despite Peter admitting that it was fault the way Ergon handled the lack of consultation and it should have been done better, below is their inadequate responses.

Ergon agreed to extend the **one** graduating apprentice in Atherton by 3 months post trade pending further discussions with FN Delegate Rob Hill regarding the vacant scheduler role and options that may open. Many more graduating apprentices are still in limbo.

Ergon Hub managers will arrange meetings with the Snr delegates by Feb 5 regarding the above vacancies and discuss crew numbers across each depot, These meetings have occurred in the past without acceptable outcomes so I see little coming out of these proposed meetings other than further delays.

Ergon will consider the option of a 6 month fixed term for unsuccessful graduating apprentices and respond within 4 weeks, further delays and no commitments.

Ergon will advise us if they still intend to go to contract for the 45000 hrs and street light maintenance by next week, further delays and they are likely to still propose outsourcing the equivalent of 70 jobs.

Ergon will formally consult with us on their proposal to extend inspection cycles(I have told them to get stuffed in this proposal, no way will we accept increasing the risk significantly to save a dollar)

Following that Ergon will consult with us on the forward works plan, we have been trying to get answers for months since the AER handed down its final determination. My view is they are juggling the figures to justify cutting frontline jobs despite not responding to our counter report in the attached email. We asked why Ergon is cutting field workers instead of reviewing the indirect costs coming out of the reduced budgets and the only response we received from Peter Billing was those costs are required to get the jobs ready.

We maintained our position that it is Ergon's responsibility to minimise indirect costs and maintain frontline field workers.

I further raised our concerns that if they close out the vacancies and cut these 27 jobs that Ergon will not have adequate resources to respond in a timely manner in the case of a major storm event. Peter Billings response was "you don't need resources in the area, you only need to be able to mobilise resources". Any Manager with a skerrick of industry knowledge would know that the first few days of a response are critical to have local staff with local knowledge on the ground making safe and then restoring supply to vital infrastructure. Mobilising workers and getting them operational takes at least 3-4 days at the very best due to flooding, mobilisation timeframes and distances, lack of vehicles or tooling if resources are

flown in, lack of similar work practices. This is further exacerbated due to lack of local knowledge.

Not only are their proposals a safety issue they will also impact on Queensland Regional communities already suffering if and when we get hit by a storm, let alone the further loss of jobs.

The Premier and Energy Minister were only on the news this week talking about fast tracking projects for employment opportunities in NQ following Palmers cuts in the same week Ergon is proposing job cuts at Qld expense.

As a result Atherton walked off the job in disgust last week and endorsed this resolution,

“We the ETU members from Atherton Depot upon hearing a report from our Union representatives regarding the alleged reduced works programme and the intended plan by Ergon to reduce internal resources demand that self- interested Ergon management urgently and genuinely consult with ETU representatives to address the current critical resources that are leading to serious safety issues. Furthermore we call on the Shareholding Ministers to ensure that the maintenance standard of the Electricity Network is maintained to long established standards and that frontline critical positions are backfilled and maintained to ensure adequate resources are available to respond to major storm events”.

I am sure this will escalate to other areas based on the volume of calls I am receiving by ETU members that have had a gut full of the self-serving Senior Managers looking to square up on us following the defeat of their LNP mates.

Cheers,

Stuart Traill

Supply Industry Coordinator

Electrical Trades Union

Queensland

M NR

F. (07) 40513502

stuart@etu.org.au

www.etu.org.au



Join Online

www.etuyes.com

Or call

1800ETUYES



Released under RTI Act 2009

<http://www.not4sale.org.au/>

Peter, Jeff,

Attached is a report outlining our concerns that Ergon is overstating the impacts of the AER final determination in an attempt to reduce maintenance costs and associated internal resources.

It is our view that Ergon's intent to extend inspection cycles, reduce maintenance, close internal vacancies and reduce field workers will lead to an increased risk to the public and our members.

Can this be placed on the agenda for the next Consultation forum and further we request that Ergon provides responses to the issues raised in this report?

Cheers,

Stuart Trill
Supply Industry Coordinator
Electrical Trades Union
Queensland
M. NR
F. (07) 40513502
stuart@etu.org.au
www.etu.org.au



Join Online
www.etuyes.com
Or call
1800ETUYES



www.not4sale.org.au

--Forwarded Message Attachment--

From: stuart@etu.org.au

To: Peter.BILLING@ergon.com.au; jeffrey.green@ergon.com.au

CC: Greg.Bloom@ergon.com.au; Jason.Conway@ergon.com.au; Chris.McGaw@Ergon.com.au;

Robert.Hill@ergon.com.au; ian.nix@ergon.com.au; scott.sologinkin@ergon.com.au

Subject: AER Counter Report

Date: Tue, 12 Jan 2016 03:58:05 +0000

Peter, Jeff,

Attached is a report outlining our concerns that Ergon is overstating the impacts of the AER final determination in an attempt to reduce maintenance costs and associated internal resources.

It is our view that Ergon's intent to extend inspection cycles, reduce maintenance, close internal vacancies and reduce field workers will lead to an increased risk to the public and our members.

Can this be placed on the agenda for the next Consultation forum and further we request that Ergon provides responses to the issues raised in this report?

Cheers,

Stuart Traill

Supply Industry Coordinator

Electrical Trades Union

Queensland

M

F. (07) 40513502

stuart@etu.org.au

www.etu.org.au



Join Online

www.etuyes.com

Or call

1800ETUYES

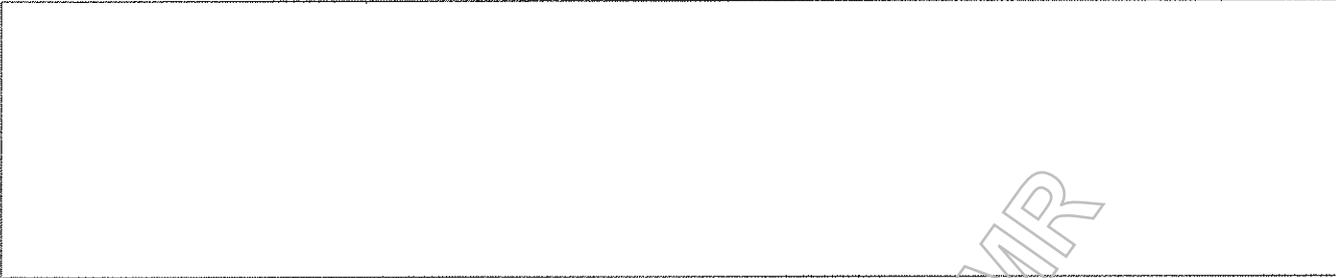

www.not4sale.org.au



Released under RTI Act - TMR

Subject: Re: ^_FYI^_...

From: Tam.VanAlphen@ministerial.qld.gov.au

To: mangocube6@yahoo.co.uk

Date: Friday, 6 November 2015 05:01:07 PM AEST

Hmphf!

Sent from my iPhone

> On 6 Nov 2015, at 3:42 pm, Mark Bailey <mangocube6@yahoo.co.uk> wrote:

>

> @saveexit190: Member for Caloundra Mark McArdle is making urgent contact with the Department of Transport and Main Roads... <https://t.co/byyYCopNIS>

>

> Sent from my iPhone

This email, together with any attachments, is intended for the named recipient(s) only; and may contain privileged and confidential information. If received in error, you are asked to inform the sender as quickly as possible and delete this email and any copies of this from your computer system network.

If not an intended recipient of this email, you must not copy, distribute or take any action(s) that relies on it; any form of disclosure, modification, distribution and /or publication of this email is also prohibited.

Unless stated otherwise, this email represents only the views of the sender and not the views of the Queensland Government.

Please consider the environment before printing this email.

Released under RTI Act - TMR

Subject: FW: QUU
From: Peter Simpson (ETU) (simmo@etu.org.au)
To: mangocube6@yahoo.co.uk;
Date: Wednesday, 11 November 2015, 13:15

Mate,

Read below, a bit more to this than first appeared

From: Scott R
Sent: Wednesday, 11 November 2015 12:23 PM
To: Peter Simpson (ETU) <simmo@etu.org.au>; Brenton Muller <brenton@etu.org.au>
Subject: RE: QUU

This has been in the pipeline for a while. Our members will be \$400/week better off. Its probably going to Downer who have already done an agreement with us.

When they moved to the federal system they no longer have an agreement we can rely on to stop it and they have been pricks thru 2 elections already despite being owned by 5 councils. The media does not care. The councillors claim it will be lower water costs so media will crucify any of ours that come out against it.

Our members all want this to happen now given the benefits of government ownership disappeared under Newman and then due to QR decision and now they stand to be paid market rates - as I said minimum \$400 week more than what they are paid now. Along with redundancy payment from QUU and CIRT in the new agreement

While the principle against outsourcing remains the same, these guys have been fucked around being 'publically owned' enough that they are happy to be in the private sector and paid market rates.

Gimme a call if you want to discuss further.

Cheers,

Scott Reichman
Organiser
Electrical Trades Union QLD & NT

NR

sjr@etu.org.au
www.etu.org.au

Capitalism is the extraordinary belief that the greediest of men with the nastiest of motives will somehow work for the benefit of all.

From: Peter Simpson (ETU)
Sent: 11/11/2015 11:22

To: brenton@etu.org.au; [Scott R](#)

Subject: QUU

Comrades,

Just had a tip off that QUU are looking at outsourcing ALL jobs. As BCC owns 80%, if we can get some more guts on that we'll be able to nullify it fairly quickly I'd suggest, given the upcoming council elections

Can you do some digging, see what you can find out on the grapevine and then come back to me please, we obviously need to put together a short sharp campaign to expose this, once we have a bit more. The tip came from a very reliable source, albeit without any detail

Simmo

Regards,

Peter Simpson

State Secretary

NR

simmo@etu.org.au

Released under RTI Act - TTR

Subject: Re: QUU
From: Peter Simpson (ETU) (simmo@etu.org.au)
To: mangocube6@yahoo.co.uk;
Date: Wednesday, 11 November 2015, 15:23

So reading the tea leaves our side our boys want it outsourced do they can get paid correctly, bizarre but a sad reflection on council wages

Sent from my iPhone

On 11 Nov 2015, at 3:02 PM, Mark Bailey <mangocube6@yahoo.co.uk> wrote:

Thx Simmo. Haven't got to Harding or Milton just yet.
Sent from my iPhone

On 11 Nov 2015, at 1:15 PM, Peter Simpson (ETU) <simmo@etu.org.au> wrote:

Mate,

Read below, a bit more to this than first appeared

From: Scott R
Sent: Wednesday, 11 November 2015 12:23 PM
To: Peter Simpson (ETU) <simmo@etu.org.au>; Brenton Muller <brenton@etu.org.au>
Subject: RE: QUU

This has been in the pipeline for a while. Our members will be \$400/week better off. Its probably going to Downer who have already done an agreement with us.

When they moved to the federal system they no longer have an agreement we can rely on to stop it and they have been pricks thru 2 elections already despite being owned by 5 councils. The media does not care. The councillors claim it will be lower water costs so media will crucify any of ours that come out against it.

Our members all want this to happen now given the benefits of government ownership disappeared under Newman and then due to QR decision and now they stand to be paid market rates - as I said minimum \$400 week more than what they are paid now. Along with redundancy payment from QUU and CIRT in the new agreement

While the principle against outsourcing remains the same, these guys have been fucked around being 'publically owned' enough that they are happy to be in the private sector and paid market rates.

Gimme a call if you want to discuss further.

Cheers,

Scott Reichman

about:blank

1/2

Organiser
Electrical Trades Union QLD & NT

NR

sjr@etu.org.au
www.etu.org.au

Capitalism is the extraordinary belief that the greediest of men with the nastiest of motives will somehow work for the benefit of all.

From: Peter Simpson (ETU)
Sent: 11/11/2015 11:22
To: brenton@etu.or.au; Scott R
Subject: QUU

Comrades,

Just had a tip off that QUU are looking at outsourcing ALL jobs. As BCC owns 80%, if we can get some more guts on that we'll be able to nullify it fairly quickly I'd suggest, given the upcoming council elections

Can you do some digging, see what you can find out on the grapevine and then come back to me please, we obviously need to put together a short sharp campaign to expose this, once we have a bit more. The tip came from a very reliable source, albeit without any detail

Simmo

Regards,

Peter Simpson

State Secretary

NR

simmo@etu.org.au

Subject: Introduction

From: Sch 4 CTPI

To: mangocube6@yahoo.co.uk;

Cc: Sch 4 CTPI

Date: Wednesday, 20 January 2016, 8:41

Hi Mark,

I am introducing you to Alan Pears, who can help guide you with energy policy. Alan is the 'expert's expert' on efficiency and renewables with extensive experience at the State and Federal levels.

His contact numbers are: mob: NR home Sch 4 CTPI

Alan, Mark is the Minister for Energy (and 4 other portfolios) in the Queensland government and one of the new breed of parliamentarians who understands the need and opportunity of clean energy. Please assist in whatever way you can. This email address is his private account and he can direct you how best to communicate.

Please let me know if I can be of further assistance.

Best,

Sch 4 CTPI

Released under RTI Act TMR